

TR-45

***Lawfully Authorized
Electronic Surveillance***

***PN-4465 -
RV1***

©Copyright Telecommunications Industry Association 1997-2002

All rights reserved.

This document is subject to change.

1
2
3
4
5
6
7
8
9
10
11
12
13
14
15
16
17
18
19
20
21
22
23
24
25
26
27
28
29
30
31
32
33
34
35
36
37
38
39
40
41
42
43
44
45
46
47
48
49
50
51
52
53
54
55
56
57
58
59

1 **Abstract**
2
3
4

5 This Interim Standard defines the interfaces between a telecommunication
6 service provider (TSP) and a Law Enforcement Agency (LEA) to assist the
7 LEA in conducting lawfully authorized electronic surveillance. A TSP,
8 manufacturer, or support service provider that is in compliance with this
9 Interim Standard will have a “safe harbor” under Section 107 of the Commu-
10 nications Assistance for Law Enforcement Act (CALEA), Public Law 103-
11 414: “a [TSP] shall be found to be in compliance with the assistance
12 capability requirements under [CALEA] Section 103, and a manufacturer of
13 telecommunication transmission or switching equipment or a provider of
14 telecommunication support services shall be found in compliance with
15 [CALEA] Section 106.”
16

17 J-STD-025A provides the enhancements necessary to support FCC 99-230,
18 CC Docket No. 97-213, Third Report and Order.
19
20
21
22
23
24
25
26
27
28
29
30
31
32
33
34
35
36
37
38
39
40
41
42
43
44
45
46
47
48
49
50
51
52
53
54
55
56
57
58
59

PN-4465-RV1

Document Revision History

Revision	Date	Remarks
0	November 1997	Initial
A	April 2000	Revised to meet the requirements defined in FCC 99-230, CC Docket No. 97-213.
	December 2000	Incorporated changes from ballot review for TIA/EIA J-STD-025
	August 2001	Gray-out information vacated by the DC Circuit Court

PN-4465-RV1

1
2
3
4
5
6
7
8
9
10
11
12
13
14
15
16
17
18
19
20
21
22
23
24
25
26
27
28
29
30
31
32
33
34
35
36
37
38
39
40
41
42
43
44
45
46
47
48
49
50
51
52
53
54
55
56
57
58
59

Contents

1
2
3
4
5
6
7
8
9
10
11
12
13
14
15
16
17
18
19
20
21
22
23
24
25
26
27
28
29
30
31
32
33
34
35
36
37
38
39
40
41
42
43
44
45
46
47
48
49
50
51
52
53
54
55
56
57
58
59

Abstract	i
Document Revision History	ii
Contents	iii
List of Tables	viii
List of Figures	x
Foreword	xiii
1 Introduction	1
1.1 General	1
1.2 Purpose	2
1.3 Scope	2
1.4 Organization	2
2 References	3
3 Definitions and Acronyms	5
4 Stage 1 Description: User Perspective	16
4.1 Overview	16
4.2 Introduction	16
4.2.1 Assumptions	16
4.2.2 General Background	17
4.2.3 Call Content Channels and Call Data Channels	19
4.3 Non-Call Associated Information Surveillance Service Description—Serving System IAP	20
4.4 Call Associated Information Surveillance Service Description—Call-Identifying Information IAP	21
4.4.1 Introduction	21
4.4.2 Basic Circuit Calls	21
4.4.3 Conference Call Party Changes	22
4.5 Call Associated and Non-Call Associated Information Surveillance Service Description	22
4.5.1 Introduction	22
4.5.2 Intercept Subject Signaling IAP	23
4.5.2.1 Subject-initiated Dialing and Signaling	23
4.5.2.2 Dialed Digit Extraction	23
4.5.3 Network Signaling IAP	23
4.5.3.1 In-band and Out-of-band Signaling	23
4.6 Content Surveillance Service Description	23
4.6.1 Circuit IAP	24
4.6.2 Conference Circuit IAP - Content of Subject-initiated Conference Calls	28
4.6.3 Packet Data IAP	28
4.7 Timing Information	32
4.8 Restrictions	33
4.8.1 Lack of CDC and CCC Synchronization	33
4.8.2 CDC Congestion	33
4.8.3 CCC Exhaustion	33

4.8.4	CCC Congestion	33	1
4.9	Packet Mode Technology	34	2
4.9.1	CDMA2000 Packet Data	34	3
4.9.1.1	General Principles	34	4
4.9.1.2	Applicability to Telecommunications Services	34	5
4.9.2	Packet Technology B	34	6
4.9.3	Packet Technology C	34	7
			8
			9
5	Stage 2 Description: Network Perspective	35	10
5.1	Introduction	35	11
5.2	Stage 2 Methodology	35	12
5.3	Network Reference Model	36	13
5.3.1	Functional Entities	37	14
5.3.1.1	Access Function (AF)	37	15
5.3.1.2	Delivery Function (DF)	37	16
5.3.1.3	Collection Function (CF)	38	17
5.3.1.4	Service Provider Administration Function (SPAF)	38	18
5.3.1.5	Law Enforcement Administration Function (LEAF)	38	19
			20
5.3.2	Interface Reference Points	38	21
5.3.2.1	Reference Point <i>a</i>	38	22
5.3.2.2	Reference Point <i>b</i>	38	23
5.3.2.3	Reference Point <i>c</i>	39	24
5.3.2.4	Reference Point <i>d</i>	39	25
5.3.2.5	Reference Point <i>e</i>	39	26
			27
5.4	Message Descriptions	39	28
5.4.1	Answer	40	29
5.4.2	CCClose	41	30
5.4.3	CCOpen	42	31
5.4.4	Change	44	32
5.4.5	ConferencePartyChange	45	33
5.4.6	Connection	47	34
5.4.7	ConnectionBreak	48	35
5.4.8	DialedDigitExtraction	49	36
5.4.9	NetworkSignal	50	37
			38
5.4.10	Origination	53	39
5.4.11	PacketEnvelope	55	40
5.4.12	Redirection	56	41
5.4.13	Release	57	42
5.4.14	ServingSystem	58	43
5.4.15	SubjectSignal	59	44
5.4.16	TerminationAttempt	60	45
			46
6	Stage 3 Description: Implementation Perspective	62	47
6.1	Protocol Definition	62	48
6.2	CDC Protocol Definition	62	49
6.2.1	CDC Underlying Data Transmission	62	50
6.2.2	CDC Parameter Encoding Objectives	62	51
6.2.3	CDC Syntax Definitions	63	52
			53
6.3	CDC Message Definitions	64	54
6.3.1	Answer Message	64	55
6.3.2	CCClose Message	65	56
6.3.3	CCOpen Message	65	57
6.3.4	Change Message	65	58
			59

1	6.3.5	ConferencePartyChange Message	66
2	6.3.6	Connection Message	67
3	6.3.7	ConnectionBreak Message	67
4	6.3.8	DialedDigitExtraction Message	68
5	6.3.9	NetworkSignal Message	68
6			
7	6.3.10	Origination Message	69
8	6.3.11	PacketEnvelope Message	70
9	6.3.12	Redirection Message	71
10	6.3.13	Release Message	71
11	6.3.14	ServingSystem Message	72
12	6.3.15	SubjectSignal Message	72
13	6.3.16	TerminationAttempt Message	73
14	6.4	CDC Parameter Definitions	74
15	6.4.1	AlertingSignal	74
16	6.4.2	AudibleSignal	74
17	6.4.3	BearerCapability	75
18	6.4.4	CallIdentity	75
19	6.4.5	CaseIdentity	75
20	6.4.6	CCIdentity	76
21	6.4.7	IAPSystemIdentity	76
22	6.4.8	Location	76
23	6.4.9	PartyIdentity	77
24	6.4.10	PDUType	78
25	6.4.11	RedirectedFromInformation	78
26	6.4.12	TerminalDisplayInfo	79
27	6.4.13	TimeStamp	79
28	6.4.14	TransitCarrierIdentity	79
29			
30	6.5	CCC Protocols	80
31	6.5.1	CCC Encoding for Circuit-Mode Services	80
32	6.5.2	CCC Encoding for Packet-Mode Services	80
33			
34	6.6	LAESP Compatibility Guidelines	80
35	6.6.1	Guidelines For Forward Compatibility	80
36	6.6.2	Guidelines For Backward Compatibility	81
37	6.6.2.1	Existing Messages	81
38	6.6.2.2	Parameters in Existing Messages	81
39	6.6.2.3	New Messages	82
40	6.6.2.4	New Parameters	82
41	6.6.2.5	New Parameter Fields	82
42	6.6.2.6	New Parameter Values	82
43			
44			
45	Annex A	Deployment Examples	83
46	A.1	Possible Network Deployment of IAPs	83
47	A.2	Access and Delivery Function Equipment Configuration	85
48	A.3	Implementation of the <i>d</i> -interface	88
49	A.4	Implementation of the <i>e</i> -interface	90
50	A.5	Possible CDC Protocol Stacks	92
51	A.6	Possible CCC Protocol Stacks	93
52			
53			
54	Annex B	CCC Delivery Methods	96
55	B.1	Circuit-Mode vs. Packet-Mode	96
56	B.2	Overview	97
57	B.3	Dedicated Circuit CCC Delivery	98
58	B.3.1	Obtain Network Address of Destination	99
59			

B.3.2	Setup CCC to Destination	99	1
B.3.3	Destination Acceptance or Refusal of a CCC	100	2
B.3.4	CCC Continuity Verification	100	3
B.3.5	Associate Intercept Subject and Call Identity to the CCC	101	4
B.3.6	Call Content Transfer	101	5
B.3.7	Early CCC Release by the Destination	102	6
B.3.8	Disassociate CCC	102	7
B.3.9	Normal CCC Release by the Source.	102	8
B.4	Trunk Group CCC Delivery	103	9
B.4.1	Obtain Network Address of Destination	104	10
B.4.2	Setup CCC to Destination	104	11
B.4.3	Destination Acceptance or Refusal of a CCC	105	12
B.4.4	CCC Continuity Verification	108	13
B.4.5	Associate Intercept Subject and Call Identity to the CCC	108	14
B.4.6	Call Content Transfer	109	15
B.4.7	Early CCC Release by the Destination	109	16
B.4.8	Disassociate CCC	110	17
B.4.9	Normal CCC Release by the Source	110	18
B.5	Static Directory Number CCC Delivery	111	19
B.5.1	Obtain Network Address of Destination	112	20
B.5.2	Setup CCC to Destination	112	21
B.5.3	Destination Acceptance or Refusal of a CCC	113	22
B.5.4	CCC Continuity Verification	113	23
B.5.5	Associate Intercept Subject and Call Identity to the CCC	113	24
B.5.6	Call Content Transfer	113	25
B.5.7	Early CCC Release by the Destination.	113	26
B.5.8	Disassociate CCC	114	27
B.5.9	Normal CCC Release by the Source	114	28
B.6	Packet Data CCC Delivery	114	29
B.6.1	Obtain Network Address of Destination	115	30
B.6.2	Setup CCC to Destination	115	31
B.6.3	Destination Acceptance or Refusal of a CCC	115	32
B.6.4	CCC Continuity Verification	115	33
B.6.5	Associate Intercept Subject and Call Identity to the CCC	116	34
B.6.6	Call Content Transfer	116	35
B.6.7	Early CCC Release by the Destination	116	36
B.6.8	Disassociate CCC	116	37
B.6.9	Normal CCC Release by the Source	116	38
B.7	Delivery Bearer Service	116	39
B.8	Separated Content Delivery	117	40
B.9	Combined Content Delivery	117	41
B.10	Signaling for Switched Delivery	118	42
B.11	Call Content Delivery Delay	118	43
B.12	Call Content Distribution	119	44
B.13	DTMF C-Tone Signaling Procedures	119	45
Annex C	CDC Delivery Methods	121	46
C.1	Dedicated Data Circuit CDC Delivery	121	47
C.2	Dedicated Data Link CDC Delivery	122	48
C.3	Call Data Distribution	122	49
Annex D	Information Access Scenarios	123	50
D.1	Simple Abandoned Call Attempt	127	51

1	D.2	Partial Dial Abandon	127
2	D.3	Pre-Answer Abandon	128
3	D.4	Simple Outgoing Call	129
4	D.5	Re-Origination	130
5	D.6	Simple Incoming Call	131
6	D.7	Call Waiting and Recall	132
7		D.7.1 Call Waiting and Recall with a Single Call Identity	133
8		D.7.2 Call Waiting and Recall with Separate Leg Identities	134
9		D.7.3 Call Waiting and Recall with Separate Calls	135
10	D.8	Call Waiting with Talking Party Disconnect	136
11		D.8.1 Call Waiting with Talking Party Disconnect and a Single Call Identity	137
12		D.8.2 Call Waiting with Talking Party Disconnect and Separate Leg Identities	138
13		D.8.3 Call Waiting with Talking Party Disconnect and Separate Calls	139
14	D.9	Call Held and Retrieved	140
15	D.10	Three-Way Calling, Plus Call Turned Away	141
16		D.10.1 Three-Way Calling, Plus Call Turned Away with a Single Call Identity	141
17		D.10.2 Three-Way Calling, Plus Call Turned Away with Separate Leg Identities	143
18		D.10.3 Three-Way Calling, Plus Call Turned Away with Separate Calls	144
19	D.11	Call Forwarding—No Answer on a Single System	146
20	D.12	Call Forwarding—No Answer on Different Systems	147
21	D.13	Two Bearer Channels, Plus Call Transfer	148
22	D.14	Speed Calling	149
23	D.15	Multiple Translations on Single System	150
24	D.16	Multiple Call Scenario	151
25	D.17	Simple Call Delivery to a Mobile Station	152
26	D.18	Password Call Acceptance and Flexible Alerting	154
27	D.19	Password Call Acceptance and Call Forwarding	155
28	D.20	Completed Call To Busy Subscriber	156
29	D.21	Dialed Feature Code Digits	157
30	D.22	Call Release to Pivot	157
31	D.23	Intrasystem Handoff	159
32	D.24	Handoff to a Third System without Path Minimization	159
33	D.25	Connected Party Modification	161
34			
35			
36			
37			
38			
39			
40	Annex E	Information Access Scenarios - J-STD-025A	162
41	E.1	Conference Call	162
42		E.1.1 Conference Call (ConferencePartyChange using PartyIdentities)	162
43		E.1.2 Conference Call (ConferencePartyChange using CallIdentities)	166
44		E.1.3 Conference Call (Connection/ConnectionBreak using PartyIdentities)	170
45	E.2	Call Waiting	173
46		E.2.1 Call Waiting with Recall (NetworkSignal and SubjectSignal)	174
47	E.3	Multi-stage Dialing (DialedDigitExtraction)	176
48			
49			
50	Annex F	Optional Messages	178
51	F.1	ConnectionTest Message	178
52			
53	Annex G	Possible e-Interface Delivery Methods	179
54			
55	Annex H	LAES Administrative Interfaces	180
56			
57			
58			
59			

List of Tables

		1
		2
		3
		4
Table 1:	Answer Message Parameters	40
Table 2:	CCClose Message Parameters	41
Table 3:	CCOpen Message Parameters	43
Table 4:	Change Message Parameters	44
Table 5:	ConferencePartyChange Message Parameters	46
Table 6:	Connection Message Parameters	47
Table 7:	ConnectionBreak Message Parameters	48
Table 8:	DialedDigitExtraction Message Parameters	49
Table 9:	NetworkSignal Message Parameters	52
Table 10:	Origination Message Parameters	54
Table 11:	PacketEnvelope Message Parameters	55
Table 12:	Redirection Message Parameters	56
Table 13:	Release Message Parameters	57
Table 14:	ServingSystem Message Parameters	58
Table 15:	SubjectSignal Message Parameters	59
Table 16:	TerminationAttempt Message Parameters	60
Table 17:	IAP Primary Locations	83
Table 18:	Simple Switch Connections (Sheet 1 of 3)	124
Table 19:	Simple Abandoned Call Attempt Scenario	127
Table 20:	Partial Dial Abandon Scenario	127
Table 21:	Pre-Answer Abandon Scenario	128
Table 22:	Simple Outgoing Call Scenario	129
Table 23:	Alternate Steps for <i>en bloc</i> Sending	129
Table 24:	Re-origination Call Scenario	130
Table 25:	Alternate Re-origination Call Scenario Steps	131
Table 26:	Simple Incoming Call Scenario	131
Table 27:	Call Waiting with Recall Scenario with a Single Call Identity	133
Table 28:	Call Waiting with Recall with Separate Leg Identities Scenario	134
Table 29:	Call Waiting with Recall with Separate Calls Scenario	135
Table 30:	Call Waiting with Talking Party Disconnect and a Single Call Identity Scenario	137
Table 31:	Call Waiting with Talking Party Disconnect and Separate Leg IdentitiesScenario	138
Table 32:	Call Waiting with Talking Party Disconnect and Separate Calls Scenario	139
Table 33:	Call Held and Retrieved Scenario	140
Table 34:	Three-Way Calling with a Single Call Identity Scenario (Sheet 1 of 2)	141
Table 35:	Three-Way Calling Scenario with Separate Leg Identities (Sheet 1 of 2)	143
Table 36:	Three-Way Calling with Separate Call Scenario (Sheet 1 of 2)	144
Table 37:	Call Forwarding—No Answer on a Single System Scenario	146
Table 38:	Call Forwarding—No Answer on Different Systems Scenario	147
Table 39:	Two Bearer Channels, Plus Call Transfer Scenario (Sheet 1 of 2)	148
Table 40:	Speed Calling Scenario	149
Table 41:	Multiple Translations on a Single System Scenario	150
Table 42:	Multiple Call Scenario	151
Table 43:	Simple Call Delivery Scenario (Sheet 1 of 2)	152
Table 44:	Password Call Acceptance and Flexible Alerting Scenario	154
Table 45:	Password Call Acceptance and Call Forwarding Scenario	155
Table 46:	Completed Call To Busy Subscriber	156
Table 47:	Dialed Feature Code Digits Scenario	157
Table 48:	Call Release to Pivot Scenario (Sheet 1 of 2)	157
Table 49:	Intrasystem Handoff Scenario	159
Table 50:	Handoff to a Third System without Path Minimization Scenario (Sheet 1 of 2)	159
		59

1
2
3
4
5
6
7
8
9
10
11
12
13
14
15
16
17
18
19
20
21
22
23
24
25
26
27
28
29
30
31
32
33
34
35
36
37
38
39
40
41
42
43
44
45
46
47
48
49
50
51
52
53
54
55
56
57
58
59

Table 51: Connected Party Modification Scenario 161

Table 52: Conference Call (ConferencePartyChange using PartyIdentities) Scenario
.....(Sheet 1 of 4) 162

Table 53: Conference Call (ConferencePartyChange using CallIdentities) Scenario
.....(Sheet 1 of 4) 166

Table 54: Conference Call (Connection/ConnectionBreak using PartyIdentities) Scenario
.....(Sheet 1 of 3) 170

Table 55: Call Waiting with Recall Scenario (Sheet 1 of 2) 174

Table 56: Multi-stage Dialing (DialedDigitExtraction) Scenario (Sheet 1 of 2) 176

Table 57: ConnectionTest Message Parameters 178

List of Figures

		1
		2
		3
		4
<i>Figure 1:</i>	Electronic Surveillance Model	18
<i>Figure 2:</i>	Call Content Channels and Call Data Channels	20
<i>Figure 3:</i>	Circuit IAP for a Two-Way Communication	25
<i>Figure 4:</i>	Circuit IAP for a Multi-Party Communication	26
<i>Figure 5:</i>	Circuit IAP for an Incoming Call	27
<i>Figure 6:</i>	Circuit IAP for a Redirected Call	28
<i>Figure 7:</i>	Packet Data IAP to a Separated CCC (appropriate to all data services)	30
<i>Figure 8:</i>	Packet Data IAP to a Combined CCC (connectionless data services only)	31
<i>Figure 9:</i>	Packet Data IAP to a CDC (for selected packet types)	32
<i>Figure 10:</i>	Network Reference Model	36
<i>Figure 11:</i>	Land Line IAPs	83
<i>Figure 12:</i>	Mobile Intercept Subject's Home System IAPs	84
<i>Figure 13:</i>	Mobile Intercept Subject's Serving System IAPs	84
<i>Figure 14:</i>	Mobile Intercept Subject's Redirecting System IAPs	85
<i>Figure 15:</i>	External Delivery Function	85
<i>Figure 16:</i>	Integrated Delivery Function with a Non-Distinct Administration Interface	86
<i>Figure 17:</i>	Integrated Delivery Function with a Distinct Administration Interface	86
<i>Figure 18:</i>	Mobile Telephone Systems with Two TSPs	87
<i>Figure 19:</i>	Independently Administered External Pivoted Delivery	88
<i>Figure 20:</i>	Bridged Access	89
<i>Figure 21:</i>	Looped Access	90
<i>Figure 22:</i>	Possible Transmission Schemes for the e-Interface	91
<i>Figure 24:</i>	Possible Circuit-Mode CCC Protocol Stacks	94
<i>Figure 25:</i>	Possible Packet-Mode CCC Protocol Stacks	95
<i>Figure 26:</i>	Dedicated Circuit CCC Delivery	98
<i>Figure 27:</i>	Setup CCC Using Dedicated Circuits	99
<i>Figure 28:</i>	Associate CCC Using Dedicated Circuits	101
<i>Figure 29:</i>	Transfer Call Content Using Dedicated Circuits	101
<i>Figure 30:</i>	Disassociate CCC Using Dedicated Circuits	102
<i>Figure 31:</i>	Dedicated Circuit CCC Release	103
<i>Figure 32:</i>	Trunk Group CCC Delivery	103
<i>Figure 33:</i>	Setup CCCs Using a Trunk from a Trunk Group	104
<i>Figure 34:</i>	Acceptance of CCCs Using a Trunk of a Trunk Group	105
<i>Figure 35:</i>	DF Timed Refusal of a CCC Using a Trunk of a Trunk Group	106
<i>Figure 36:</i>	CF Timed Refusal of a CCC Using a Trunk of a Trunk Group	106
<i>Figure 37:</i>	DF Refusal of a CCC Using a Trunk of a Trunk Group	107
<i>Figure 38:</i>	CF Refusal of a CCC Using a Trunk of a Trunk Group	107
<i>Figure 39:</i>	CCC Continuity Test	108
<i>Figure 40:</i>	Transfer Call Content Using a Trunk in a Trunk Group	109
<i>Figure 41:</i>	Early Release of CCC Using a Trunk in a Trunk Group	109
<i>Figure 42:</i>	Release CCC Using a Trunk in a Trunk Group	110
<i>Figure 43:</i>	Static Directory Number CCC Delivery	111
<i>Figure 44:</i>	Setup Trunk to Destination	112
<i>Figure 45:</i>	Packet Data CCC Delivery	115
<i>Figure 46:</i>	Separated Content Delivery	117
<i>Figure 47:</i>	Combined Content Delivery	117
<i>Figure 48:</i>	Call Content Distribution	119
<i>Figure 49:</i>	Pivoted Delivery with Distribution	119
<i>Figure 50:</i>	Digit to DTMF Tone Mapping	120
<i>Figure 51:</i>	DTMF C-tone Signaling	120
		59



1
2
3
4
5
6
7
8
9
10
11
12
13
14
15
16
17
18
19
20
21
22
23
24
25
26
27
28
29
30
31
32
33
34
35
36
37
38
39
40
41
42
43
44
45
46
47
48
49
50
51
52
53
54
55
56
57
58
59

Figure 52: Dedicated Data Circuit CDC Delivery 121
Figure 53: Dedicated Data Link CDC Delivery 122
Figure 54: Switch Connection Diagram Conventions 124

1
2
3
4
5
6
7
8
9
10
11
12
13
14
15
16
17
18
19
20
21
22
23
24
25
26
27
28
29
30
31
32
33
34
35
36
37
38
39
40
41
42
43
44
45
46
47
48
49
50
51
52
53
54
55
56
57
58
59

(This page intentionally left blank.)

Foreword

This foreword is not part of this Interim Standard.

The specification of interface compatibility requirements between telecommunication service providers (TSPs) and law enforcement agencies (LEAs) was developed as a Joint Standards Project between ANSI accredited Telecommunications Industry Association Committee TR-45 and ANSI accredited Committee T1–Telecommunications.

This Interim Standard defines the interfaces between a telecommunication service provider (TSP) and a Law Enforcement Agency (LEA) to assist the LEA in conducting lawfully authorized electronic surveillance. A TSP, manufacturer, or support service provider that is in compliance with this Interim Standard will have a “safe harbor” under Section 107 of the Communications Assistance for Law Enforcement Act (CALEA), Public Law 103-414: “a [TSP] shall be found to be in compliance with the assistance capability requirements under [CALEA] Section 103, and a manufacturer of telecommunication transmission or switching equipment or a provider of telecommunication support services shall be found in compliance with [CALEA] Section 106.”

There are seven annexes in this Interim Standard. All annexes are informative and are not considered part of this Interim Standard.

J-STD-025A provides the enhancements necessary to support FCC 99-230, CC Docket No. 97-213, Third Report and Order. ~~The enhancements are identified by underlined text, change bars, or both.~~

~~Double underlined text indicates an Addendum to J-STD-025.~~

Information contained in Annexes A through D, F and G does not reflect additional terms, concepts, requirements, messages or parameters for capabilities added in J-STD-025A as mandated in FCC 99-230, CC Docket No. 97-213.

1
2
3
4
5
6
7
8
9
10
11
12
13
14
15
16
17
18
19
20
21
22
23
24
25
26
27
28
29
30
31
32
33
34
35
36
37
38
39
40
41
42
43
44
45
46
47
48
49
50
51
52
53
54
55
56
57
58
59

1
2
3
4
5
6
7
8
9
10
11
12
13
14
15
16
17
18
19
20
21
22
23
24
25
26
27
28
29
30
31
32
33
34
35
36
37
38
39
40
41
42
43
44
45
46
47
48
49
50
51
52
53
54
55
56
57
58
59

(This page intentionally left blank.)

1 Introduction

1.1 General

This Interim Standard defines the interfaces between a telecommunication service provider (TSP) and a Law Enforcement Agency (LEA) to assist the LEA in conducting lawfully authorized electronic surveillance. A TSP, manufacturer, or support service provider that is in compliance with this Interim Standard will have a “safe harbor” under Section 107 of the Communications Assistance for Law Enforcement Act (CALEA), Public Law 103-414: “a [TSP] shall be found to be in compliance with the assistance capability requirements under [CALEA] Section 103, and a manufacturer of telecommunication transmission or switching equipment or a provider of telecommunication support services shall be found in compliance with [CALEA] Section 106.”

J-STD-025A provides the enhancements necessary to support FCC 99-230, CC Docket No. 97-213, Third Report and Order.

As used in this Interim Standard, electronic surveillance refers to the interception and monitoring of communications (i.e., call content), call-identifying information, or both, for a particular telecommunication subscriber as lawfully authorized. In this Interim Standard intercept subject, or more simply a subject, is a telecommunication service subscriber whose communications, call-identifying information, or both, have been authorized by a court to be intercepted and delivered to an LEA. The identification of the subject is limited to identifiers used to access the particular equipment, facility, or communication service (e.g., network address, terminal identity, subscription identity).

As a precondition for a TSP’s assistance with Lawfully Authorized Electronic Surveillance (LAES), an LEA must serve a TSP with the necessary legal authorization identifying the intercept subject, the communications and information to be accessed, and service areas where the communications and information can be accessed. Once this authorization is obtained, the TSP shall perform the access and delivery for transmission to the government’s procured equipment, facilities, or services.

LEAs recognize that in many instances the telecommunication services subscribed to by certain intercept subjects may permit a TSP to access and deliver communications and call-identifying information without the TSP having to modify its networks or systems. In these instances, the TSP may be fully compliant with the assistance capability requirements set forth in CALEA. For example, a TSP could effect a central office- or local loop-based interception using conventional methods of access and delivery and fully meet an LEA’s electronic surveillance needs.

PN-4465-RV1

1.2 Purpose

The purpose of this Interim Standard is to facilitate a TSP’s compliance with the assistance capability requirements defined in Section 103 of CALEA. This Interim Standard defines services and features to support LAES and the interfaces to deliver intercepted communications and call-identifying information to an LEA when authorized. This Interim Standard also defines a protocol for delivering specific information elements to LEAs. Compliance with this Interim Standard satisfies the “safe harbor” provisions of Section 107 of CALEA and helps ensure efficient and industry-wide implementation of the assistance capability requirements.

1.3 Scope

The scope of this Interim Standard is to define the services to support LAES and the interface between a TSP and an LEA.

1.4 Organization

Section 2 “References” is a list of references used in the preparation of this Interim Standard.

Section 3 “Definitions and Acronyms” defines words and acronyms that are used in this Interim Standard.

Section 4 “Stage 1 Description: User Perspective” defines the LAES services from the user point of view. The user in this case is the LEA.

Section 5 “Stage 2 Description: Network Perspective” defines the network entities and information flows to implement LAES services from a network point of view.

Section 6 “Stage 3 Description: Implementation Perspective” defines the messages and information elements to implement LAES services from an implementation point of view.

PN-4465-RV1

1
2
3
4
5
6
7
8
9
10
11
12
13
14
15
16
17
18
19
20
21
22
23
24
25
26
27
28
29
30
31
32
33
34
35
36
37
38
39
40
41
42
43
44
45
46
47
48
49
50
51
52
53
54
55
56
57
58
59

2 References

International Telecommunications Union (ITU) standards:

- [G.711] ITU-T Recommendation G.711, *Pulse Code Modulation (PCM) of Voice Frequencies*.
- [X.208] ITU-T Recommendation X.208, *Specification of Basic Encoding Rules for Abstract Syntax Notation One (ASN.1)*.
- [X.209] ITU-T Recommendation X.209, *Specification of Abstract Syntax Notation One (ASN.1)*.
- [Q.931] ITU-T Recommendation Q.931, *ISDN User-network Interface Layer 3 Specification for Basic Call Control*.
- [X.25] ITU-T Recommendation X.25, *Interface Between Data Terminal Equipment (DTE) and Data Circuit Terminating Equipment (DCE) for Terminals Operating in the Packet Mode and Connected to Public Data Networks by Dedicated Circuit*.

American National Standards Institute (ANSI) T1 standards:

- [T1.607] ANSI T1.607, *Integrated Services Digital Network (ISDN)—Layer 3 Signaling Specification for Circuit-Switched Bearer Service for Digital Subscriber Signaling System Number 1 (DSS1)*.
- [ANSI-41] ANSI/TIA/EIA-41-D, *Cellular Radiotelecommunications Intersystem Operations, Telecommunications Industry Association, 1997*.

Federal Communications Commission (FCC):

FCC 99-230, CC Docket No. 97-213, Third Report and Order, Released 8/31/99.

Telcordia Publications:

- [LSSGR] GR-506-CORE, *LSSGR: Signaling for Analog Interfaces (A Module of the LATA Switching Systems Generic Requirements [LSSGR], FR-64, January 1, 1999)*, Issue 1, June 1996, Revision 1, November 1996.
- [GR-268] GR-268-CORE, *ISDN Basic Rate Interface Call Control Switching and Signaling Generic Requirements*, Issue 1, July 1998.

[TR-444] TR-NWT-000444, *Switching System Requirements Supporting ISDN Access Using the ISDN User Part*, Issue 3, May 1993.

European Telecommunications Standards Institute (ETSI):

3rd Generation Partnership Project (3GPP):

[GSM 02.40] GSM 02.40, *Digital cellular telecommunications system (Phase 2+); Procedure for call progress indications*, Release 1998.

[3G TS 33.106] 3rd Generation Partnership Project; Technical Specification Group Services and System Aspects; 3G Security; Lawful Interception Requirements.

[3G TS 33.107] 3rd Generation Partnership Project; Technical Specification Group Services and System Aspects; 3G Security; Lawful Interception Architecture and Functions.

Internet Engineering Task Force (IETF):

[IP] RFC791, *Internet Protocol*, 09-01-1981.

[PPP] RFC1661, *Point-to-Point Protocol*, 07-1994.

PN-4465-RV1

1
2
3
4
5
6
7
8
9
10
11
12
13
14
15
16
17
18
19
20
21
22
23
24
25
26
27
28
29
30
31
32
33
34
35
36
37
38
39
40
41
42
43
44
45
46
47
48
49
50
51
52
53
54
55
56
57
58
59

3 Definitions and Acronyms

abandoned: a call attempt that is released by the originating party before it is answered.

access: the technical capability to interface with a communications facility, such as a communications line or switch, so that intercepted call-identifying information and call content can be delivered to an LEA.

AF: Access Function.

agent: a network-based service or device that acts on behalf of a subscriber to send or receive communications (e.g., an interactive screening service, a reminder service, a delayed transmission service).

AMPS: Advanced Mobile Phone System, one of several wireless access methods.

ANSI: American National Standards Institute.

answering party: the party answering a call. This party may be different from the called party (e.g., a called number may alert a number of stations and the answering party may be any one of the alerting stations).

ASN.1: Abstract Syntax Notation One.

associate: a telecommunication user whose equipment, facilities, or services are communicating with a subject.

ATM: Asynchronous Transfer Mode.

B-channel: a 56- or 64-kbps ISDN Bearer channel.

BER: Basic Encoding Rules.

BRI: ISDN Basic Rate Interface consisting of two 64-kbps B-channels and one 16-kbps D-channel.

CALEA: Communications Assistance for Law Enforcement Act.

call: a sequence of events beginning with an initial connection or facility request and ending with the final release of all facilities used. A call may have one or more legs.

call appearance: an instance of a possible call with direct subscriber control. A party with three call appearances may be involved in and control three calls simultaneously. Some services, such as call forwarding, do not consume call appearances, because the subscriber cannot directly control the call.

call content: see content.

call content channel (CCC): the logical link between the device performing an electronic surveillance access function and the LEA that primarily carries the call content passed between an intercept subject and one or more associates.

PN-4465-RV1

call data channel (CDC): the logical link between the device performing an electronic surveillance access function and the LEA that primarily carries call-identifying information.

call deflection: allows the called party to interactively refuse an incoming call and send that call to another directory number, to voice mail, or to an announcement.

call delivery: redirects an incoming call to a mobile subscriber.

call diversion: is similar to call forwarding, except that the condition may be more complex and dynamic (e.g., its routing decisions may be based upon calling party number, calling party entry of a valid password, time-of-day, day-of-week, day-of-year, calling party location).

call forwarding: is any of several features that redirect a call to another directory number (or voice mail), if a certain condition is met.

call-identifying information: defined in CALEA Section 102 (2) to be “dialing or signaling information that identifies the origin, direction, destination, or termination of each communication generated or received by a subscriber by means of any equipment, facility, or service of a [TSP].” Call-identifying information is “reasonably available” to a TSP if it is present at an intercept access point and can be made available without the carrier being unduly burdened with network modifications. As interpreted by this Interim Standard: **destination** is the number of the party to which a call is being made (e.g., called party); **direction** is the number to which a call is re-directed or the number from which it came, either incoming or outgoing (e.g., redirected-to party or redirected-from party); **origin** is the number of the party initiating a call (e.g., calling party); and **termination** is the number of the party ultimately receiving a call (e.g., answering party).

call transfer: allows a controlling subscriber to connect two other parties and then the controlling subscriber leaves the call.

called party: the destination party of a call.

calling party: the originating party of a call.

CCC: call content channel.

CCIR: International Telecommunications Union—Radio Sector.

CCITT: International Telecommunications Union—Telecommunications Standardization Sector.

CCT: Composite CDMA/TDMA, one of several wireless access methods.

CDMA: Code Division Multiple Access, one of several wireless access methods.

CDC: call data channel.

cell: in a wireless system, the sub-area to which a set of radio resources is allocated.

CF: Collection Function.

PN-4465-RV1

1 **channel:** an independent path for communicating between two points.

2
3 **CIAP:** Circuit Intercept Access Point.

4 **circuit:** a switchable bi-directional path between two locations. A circuit
5 may be all or part of a channel. On an end-to-end circuit, separate phys-
6 ical facilities may be used for each segment of the circuit.

7
8 **circuit-mode:** a communication using bi-directional paths switched or
9 connected when the communication is established. The entire commu-
10 nication uses the same path.

11
12 **collection function:** defined in FCC 99-230, CC Docket No. 97-213 to
13 be “the location where lawfully authorized intercepted communications
14 and call-identifying information is collected by a law enforcement agen-
15 cy (LEA).”

16
17 **Commission:** defined in CALEA Section 102 (3) to be “the Federal
18 Communication Commission.”

19
20 **communication:** in this Interim Standard, communication refers to any
21 wire or electronic communication, as defined in 18 USC 2510.

22
23 **communication intercept:** see intercept.

24
25 **complete:** a call attempt that is answered.

26
27 **connection:** a relationship between two or more parties of a call to allow
28 communication between them.

29
30 **content:** defined in 18 USC 2510 (8) to be “when used with respect to
31 any wire or electronic communications, includes any information con-
32 cerning the substance, purport, or meaning of that communication.”

33
34 **content of subject-initiated conference calls:** defined in FCC 99-230,
35 CC Docket No. 97-213 to be the capability that permits an LEA to mon-
36 itor the content of conversations by all parties connected via a confer-
37 ence call when the facilities under surveillance maintain a circuit
38 connection to the call.

39
40 **controlling party:** the party invoking a feature.

41
42 **CSU:** Channel Service Unit.

43
44 **cut-through, full:** completion of a connection in both directions.

45
46 **cut-through, partial:** completion of a connection in one direction, usu-
47 ally to allow the calling party to monitor call progress tones from the
48 called end.

49
50 **D-channel:** a 16- or 64-kbps ISDN channel carrying control and signal-
51 ing information and, optionally, packetized information and telemetry.

52
53 **DC:** direct current; a signaling method for representing the switchhook
54 state of an instrument to the other end of a call using voltage or current
55 on metallic interfaces or the “A” signaling bit on a DS-0 interface.

56
57 **destination:** see call-identifying information.

58
59 **DF:** Delivery Function.

PN-4465-RV1

dialed digit extraction: defined in FCC 99-230, CC Docket No. 97-213 to be the capability that permits an LEA to receive on the call data channel digits dialed by a subject when a call is connected to another TSP's service for processing and routing.

direction: see call-identifying information.

disconnect: a request from one of the parties of the call to release all or part of a connection.

DN: Directory Number

DSU: Data Service Unit.

DTMF: Dual-Tone Multi-Frequency.

electronic communications: defined in 18 USC 2510 (12) to be "any transfer of signs, signals, writing, images, sounds, data, or intelligence of any nature transmitted in whole or in part by a wire, radio, electro-magnetic, photoelectric, or photo-optical system."

electronic messaging services: defined in CALEA Section 102 (4) to be "software-based services that enable the sharing of data, images, sound, writing, or other information among computing devices controlled by the senders or recipients of the messages."

electronic storage: defined in 18 USC 2510 (17) to be "(A) any temporary, intermediate storage of a wire or electronic communication incidental to the electronic transmission thereof; and (B) any storage of such communication by an electronic communication service for purposes of backup protection of such communication."

electronic surveillance: the statutory-based legal authorization, process, and associated technical capabilities and activities of LEAs related to the interception of wire, oral, or electronic communications while in transmission. As used herein, also includes the acquisition of call-identifying information. As used in this Interim Standard, *surveillance* refers to a single communication intercept, pen register, or trap and trace. Its usage in this Interim Standard does not include administrative subpoenas for obtaining a subscriber's toll records and information about a subscriber's service that an LEA may employ before the start of a communication intercept, pen register, or trap and trace.

ESN: Electronic Serial Number.

feature code: the digits used to invoke or access a feature.

FG-D: Feature Group D.

functional entity: a system or subsystem capable of providing a defined service. A functional entity may be implemented as a separate physical entity or it may be incorporated with other functional entities in a common physical entity.

PN-4465-RV1

1
2
3
4
5
6
7
8
9
10
11
12
13
14
15
16
17
18
19
20
21
22
23
24
25
26
27
28
29
30
31
32
33
34
35
36
37
38
39
40
41
42
43
44
45
46
47
48
49
50
51
52
53
54
55
56
57
58
59

1 **government:** defined in CALEA Section 102 (5) to be “the government
2 of the United States and any agency or instrumentality thereof, the Dis-
3 trict of Columbia, any commonwealth, territory, or possession of the
4 United States, and any State or political subdivision thereof authorized
5 by law to conduct electronic surveillance.”
6

7 **GSM:** Global System for Mobile Communications.
8

9 **handoff:** in a wireless system, the switching of the transmission means
10 used by a call in progress without disruption of this call. Within this In-
11 terim Standard handoff is synonymous with handover.
12

13 **HDLC:** High-level Data Link Control.
14

15 **HLR:** Home Location Register.
16

17 **Home Location Register (HLR):** the location register to which a user
18 identity is associated with subscriber information (e.g. equipment iden-
19 tification, directory number, profile information, current Serving Sys-
20 tem, validation period). The HLR may serve more than one MSC. The
21 HLR may be distributed over more than one physical entity.
22

23 **Home System:** the TSP system where a subscriber’s subscription infor-
24 mation is retained.
25

26 **Hz:** Hertz or cycles per second.
27

28 **IAP:** Intercept Access Point.
29

30 **IDIAP:** Call-Identifying Information Intercept Access Point.
31

32 **idle state:** a state in which there is no active communication path be-
33 tween a subscriber and the network (e.g., while on-hook).
34

35 **IMEI:** International Mobile Equipment Identifier.
36

37 **IMSI:** International Mobile Station Identifier.
38

39 **IN:** intelligent network.
40

41 **in-band and out-of-band signaling:** defined in FCC 99-230, CC Dock-
42 et No. 97-213 to be the capability that permits an LEA to be informed
43 when a network message that provides call-identifying information
44 (e.g., ringing, busy, call waiting signal, message light) is generated or
45 sent by the IAP switch to a subject using the facilities under surveil-
46 lance. Excludes signals generated by customer premises equipment
47 when no network signal is generated.
48

49 **incomplete:** a call attempt that cannot be routed to its destination (or an-
50 swered).
51
52
53
54
55
56
57
58
59

PN-4465-RV1

information service: defined in CALEA Section 102 (6) to be “(A) the offering of a capability for generating, acquiring, storing, transforming, processing, retrieving, utilizing, or making available information via telecommunication; and (B) includes—(i) a service that permits a customer to retrieve stored information from, or file information for storage in, information storage facilities; (ii) electronic publishing; and (iii) electronic messaging services; but (C) does not include any capability for a [TSP’s] internal management, control, or operation of its telecommunication network.” see telecommunication service provider.

intercept: defined in 18 USC 2510 (4) to be “the aural or other acquisition of the content of any wire, electronic, or oral communication through the use of any electronic, mechanical, or other device.”

Intercept Access Point (IAP): a point within a telecommunication system where some of the communications or call-identifying information of an intercept subject’s equipment, facilities and services are accessed.

intercept agent: see agent.

intercept subject: a telecommunication service subscriber whose communications, call-identifying information, or both, have been authorized by a court to be intercepted and delivered to an LEA. The identification of the subject is limited to identifiers used to access the particular equipment, facility, or communication service (e.g., network address, terminal identity, subscription identity).

IP: Internet Protocol.

ISDN: Integrated Services Digital Network.

ISLP: Inter-System Link Protocol.

ISUP: ISDN User Part.

ITU-R: International Telecommunications Union - Radio Sector (formerly CCIR).

ITU-T: International Telecommunications Union - Telecommunications Standardization Sector (formerly CCITT).

kbps: kilobits (1000 bits) per second.

LAES: Lawfully Authorized Electronic Surveillance.

LAESP: LAES Protocol.

LAPB: Link Access Protocol—Balanced.

LAPD: Link Access Protocol—D-channel.

Law Enforcement Agency (LEA): a government entity with the legal authority to conduct electronic surveillance (e.g., the Federal Bureau of Investigation or a local police department).

LEA: Law Enforcement Agency.

LEAF: Law Enforcement Administration Function.

PN-4465-RV1

1
2
3
4
5
6
7
8
9
10
11
12
13
14
15
16
17
18
19
20
21
22
23
24
25
26
27
28
29
30
31
32
33
34
35
36
37
38
39
40
41
42
43
44
45
46
47
48
49
50
51
52
53
54
55
56
57
58
59

leg: a bi-directional call path associated with each network facility usage attempt and subsequent usage.

LPP: Lightweight Presentation Protocol.

MF: Multi-Frequency.

MIN: Mobile Identification Number.

mobile station (MS): The MS is a telephone set using a radio link with a public or non-public base station to access telephone network services.

Mobile Switching Center (MSC): The MSC is an automatic system which constitutes the interface for user traffic between the wireless (cellular or PCS) network and other public switched networks, or other MSCs in the same or other wireless networks.

MS: Mobile Station.

MSC: Mobile Switching Center.

MSISDN: Mobile Station International Subscriber Directory Number.

MTP: Message Transfer Part.

NAMPS: Narrow AMPS, one of several wireless access methods.

network address: an address appropriate to a particular network, e.g., a directory number for the PSTN, an X.121 address for an X.25 network, or an IP address for the Internet.

off-hook: the state of a telephone instrument indicating a readiness for service; the DC signaling of the readiness for service state.

on-hook: the state of a telephone instrument indicating a request for service disconnect, release, or service idleness; the DC signaling for service disconnect, release, or service idleness.

origin: see call-identifying information.

origination: an outgoing call attempt.

packet-mode: a communication where individual packets or virtual circuits of a communication within a physical circuit are switched or routed by the accessing telecommunication system. Each packet may take a different route through the intervening network(s).

PACS: Personal Access Communications System, one of several wireless access methods.

party hold, join, drop on conference calls: defined in FCC 99-230, CC Docket No. 97-213 to be the capability that permits an LEA to identify the parties to a conference call conversation at all times.

PCM: pulse code modulation.

PCS: Personal Communications Service.

PCS1900: one of several GSM-based wireless systems.

PDIAP: Packet Data Intercept Access Point.

PN-4465-RV1

PDU: Protocol Data Unit.

pen register: defined in 18 USC 3127 (3) (10.26.01) to be ~~“a device which records or decodes electronic or other impulses which identify the numbers dialed or otherwise transmitted on the telephone line to which such device is attached, but such term does not include any device used by a provider or customer of a wire or electronic communication service for billing, or recording as an incident to billing, for communications services provided by such provider or any device used by a provider or customer of a wire communication service for cost accounting or other like purposes in the ordinary course of its business.”~~

“a device or process which records or decodes dialing, routing, addressing, or signaling information transmitted by an instrument or facility from which a wire or electronic communication is transmitted, provided, however, that such information shall not include the contents of any communication, but such term does not include any device or process used by a provider or customer of a wire or electronic communication service for billing, or recording as an incident to billing, for communications services provided by such provider or any device or process used by a provider or customer of a wire communication service for cost accounting or other like purposes in the ordinary course of its business”.

personal mobility: the ability of a user to access telecommunication services at any terminal on the basis of a personal identifier, and the capability of the network to provide those services according to the user’s service profile. Personal mobility involves the network capability to locate the terminal associated with the user for the purposes of addressing, routing, and charging of the user’s calls.

POTS: Plain Old Telephone Service. This usually refers to loop start lines with DTMF (tone) dialing or decadic (rotary) dialing.

PPP: Point-to-Point Protocol.

PRI: ISDN Primary Rate Interface consisting of twenty-three 64-kbps B-channels and one 64-kbps D-channel.

PSTN: Public Switched Telephone Network.

pulse code modulation (PCM): a method for communicating audio information using a 56 or 64 kbps digital bit stream. In the United States most PCM is encoded using the μ law rules.

Redirecting System: the TSP system where incoming calls bound to a subscriber arrive for redirection instruction. This is called an Originating System in *TIA/EIA-41*, although the calls may be originated on another system.

recall: the alerting of a party in response to a previous call (e.g., *hold recall* alerts the controlling party after leaving a party on hold for a period of time, *transfer recall* alerts the controlling party when the transfer attempt has not been answered, *automatic recall* alerts the calling party of a previous call attempt).

registration: in wireless systems, the process that informs the Home System of the location and presence of a mobile station.

PN-4465-RV1

1
2
3
4
5
6
7
8
9
10
11
12
13
14
15
16
17
18
19
20
21
22
23
24
25
26
27
28
29
30
31
32
33
34
35
36
37
38
39
40
41
42
43
44
45
46
47
48
49
50
51
52
53
54
55
56
57
58
59

release: to place facilities used for a connection in the idle state where they can be used for other connections.

roaming: in a wireless system, the movement of a mobile station within or between wireless service areas where the mobile station can be located and can receive service.

Serving System: the TSP system currently providing telecommunication service to a subscriber, especially a roaming mobile subscriber.

short message service (SMS): a packet-mode data service, intended for transmission of small data messages, for wireless subscribers.

SLIP: Serial Link Internet Protocol.

SMS: short message service.

SPAF: Service Provider Administration Function.

SPID: Service Profile Identifier.

SSIAP: Serving System Identification Intercept Access Point.

subject: see intercept subject.

subject-initiated dialing and signaling information: defined in FCC 99-230, CC Docket No. 97-213 to be the capability that permits an LEA to be informed when a subject using the facilities under surveillance uses services that provide call-identifying information, such as call forwarding, call waiting, call hold, and three-way calling. Excludes signals generated by customer premises equipment when no network signal is generated.

surveillance: within this Interim Standard surveillance refers to electronic surveillance; see electronic surveillance.

SVC: Switched Virtual Circuit.

TCP: Transmission Control Protocol.

TDMA: Time Division Multiple Access, one of several wireless access methods.

TEI: Terminal Equipment Identity.

PN-4465-RV1

telecommunication service provider¹ (TSP): defined from CALEA Section 102 (8) to be, “a person or entity engaged in the transmission or switching of wire or electronic communications as a common carrier for hire, and includes 1) a person or entity engaged in providing commercial mobile service, or 2) a person or entity engaged in providing wire or electronic communications switching or transmission service to the extent that the Commission finds such service is a replacement for a substantial portion of local telephone exchange service and that it is in the public interest to deem such a person or entity to be a [TSP] for purposes of this title. This does not include 1) persons or entities insofar as they are engaged in providing information services, and 2) any class or category of [TSPs] that the Commission exempts by rule after consultation with the U. S. Attorney General.”

telecommunication support services: defined in CALEA Section 102 (7) to be “a product, software, or service used by a [TSP] for the internal signaling or switching functions of its telecommunication network.”

terminal mobility: the ability of a terminal to access telecommunications services from different locations and while in motion, and the capability of the network to identify, locate, and communicate with that terminal. Terminal mobility while not on a call may involve *roaming*, or while on a call may involve *handoff*.

termination: an incoming call attempt. see also call-identifying information.

timing information: defined in FCC 99-230, CC Docket No. 97-213 to be the capability that permits an LEA to associate call-identifying information with the content of a call. A call-identifying message must be sent from the carrier’s IAP to the LEA’s Collection Function within eight seconds of receipt of that message by the IAP at least 95% of the time, and with the call event timestamped to an accuracy of at least 200 milliseconds.

transmission: the act of transferring communications from one location or another by a wire, radio, electromagnetic, photoelectronic, or photo-optical system.

transparent: end-to-end transmission without insertion or loss of information.

trap and trace device: defined in 18 USC 3127 (4) to be “~~a device which captures the incoming electronic or other impulses which identify the originating number of an instrument or device from which a wire or electronic communication was transmitted.~~”

“a device or process which captures the incoming electronic or other impulses which identify the originating number or other dialing, routing, addressing, and signaling information reasonable likely to identify the source of a wire of electronic communication, provided, however, that such information shall not include the contents of any communication”.

1. This Interim Standard uses the term *telecommunication service provider* instead of the CALEA term *telecommunication carrier*.

1
2
3
4
5
6
7
8
9
10
11
12
13
14
15
16
17
18
19
20
21
22
23
24
25
26
27
28
29
30
31
32
33
34
35
36
37
38
39
40
41
42
43
44
45
46
47
48
49
50
51
52
53
54
55
56
57
58
59

TSP: telecommunication service provider.

unobtrusive: not undesirably noticeable or blatant; inconspicuous; within normal call variances.

URL: Uniform Resource Locator.

USC: United States Code.

user-to-user signaling: a bi-directional packet-mode data service for wireline subscribers.

UTC: Coordinated Universal Time (as defined by the CCIR (ITU-R)).

virtual circuit: a packet-mode connection between two end-points. A virtual circuit may be *permanent* (with only a data transfer phase) or *switched* (with setup, data transfer, and release phases).

WCDMA: Wideband Code Division Multiple Access, one of several wireless access methods.

wire communications: defined in 18, USC 2510 (1) to be “any aural transfer made in whole or in part through the use of facilities for the transmission of communications by the aid of wire, cable, or other like connection between the point of origin and the point of reception (including the use of such connection in a switching station) furnished or operated by any person engaged in providing or operating such facilities for the transmission of interstate or foreign communications or communications affecting interstate or foreign commerce and such term includes any electronic storage of such communication.”

wireless: refers to cellular or personal communication service (PCS).

wireline: refers to traditional wire-based telephone service.

PN-4465-RV1

4 Stage 1 Description: User Perspective

This section describes the features and services of LAES from a user's perspective. In this case the user is the LEA and its monitoring equipment. The features and services are described with enough detail to let LEAs know what information can be collected and when it can be collected.

4.1 Overview

This Interim Standard defines the means to access communications as an intercept access service. The services fall into four categories:

- non-call associated services to provide information about intercept subjects that is not necessarily related to a call (see 4.3);
- call associated services to provide call-identifying information about calls involving the intercept subjects (see 4.4);
- call associated and non-call associated services to provide subject and network signaling call-identifying information (see 4.5); and
- content surveillance services to provide access to an intercept subject's communications (see 4.6).

Timing information requirements are defined for call-identifying messages (see 4.7).

Restrictions are defined for exceptions (see 4.8).

4.2 Introduction

4.2.1 Assumptions

LAES capabilities allow a TSP to deliver the intercepted call content (e.g., voice, packet data, modem data) and call-identifying information to an authorized LEA.

Content: is defined in 18 USC 2510 (8) to be "when used with respect to any wire or electronic communications, includes any information concerning the substance, purport, or meaning of that communication."

Call-identifying information: is defined in CALEA Section 102 (2) to be "dialing or signaling information that identifies the origin, direction, destination, or termination of each communication generated or received by a subscriber by means of any equipment, facility, or service of a [TSP]." As interpreted by this Interim Standard: *destination* is the number of the party to which a call is being made (e.g., called party); *direction* is the number to which a call is re-directed or the number from which it came, either incoming or outgoing (e.g., redirected-to party or redirected-from party); *origin* is the number of the party initiating a call (e.g., calling party); and *termination* is the number of the party ultimately receiving a call (e.g., answering party).

1 Call-identifying information is *reasonably available* if the information is
2 present at an Intercept Access Point (IAP) for call processing purposes. With
3 respect to the matters before the FCC in FCC 99-230, CC Docket No. 97-213,
4 the commission has provided the following additional guidance: call-identi-
5 fying information is “reasonably available” to a TSP if it is present at an
6 intercept access point and can be made available without the TSP being
7 unduly burdened with network modifications. Network protocols (except
8 LAESP) do not need to be modified solely for the purpose of passing call-
9 identifying information. The specific elements of call-identifying infor-
10 mation that are reasonably available at an IAP may vary between different
11 technologies and may change as technology evolves.

12
13
14 The terms *call content* and *call-identifying information* are used throughout
15 this Interim Standard. The term *call* in this Interim Standard is intended to be
16 used in a generic sense to denote a communication and is not limited to
17 circuit-mode or connection-oriented communications.

18
19
20 Not all information delivered to law enforcement is call-identifying infor-
21 mation or call content.

22
23
24 Call identities are used to correlate call-identifying information and call
25 content.

26
27
28 Synchronization of network element time-of-day clocks is not required.

29
30
31 There is no requirement to provide message integrity to ensure that the
32 message has not been altered in transmission.

33
34
35 There is no requirement to provide message sender authentication to ensure
36 the integrity of message sender identification.

37
38
39 Reporting of network signaling applied toward the associate is not required.

40
41
42 Whenever a capability is described in this Interim Standard, it is assumed that
43 LEAs shall order and acquire adequate capacity in a timely manner for the
44 capability to be performed.

45
46
47 The call-identifying and call content information can only be delivered by a
48 system for activities on that system (e.g., home system, serving system).

48 **4.2.2 General Background**

50
51
52 The intercept function is viewed as five broad categories: access, delivery,
53 collection, service provider administration, and law enforcement adminis-
54 tration. These functions are discussed functionally without regard to their
55 implementation. The relationships between these functional categories are
56 shown in [Figure 1](#).

57
58
59 The Access Function, consisting of one or more Intercept Access Points
(IAPs), isolates an intercept subject’s communications or call-identifying

PN-4465-RV1

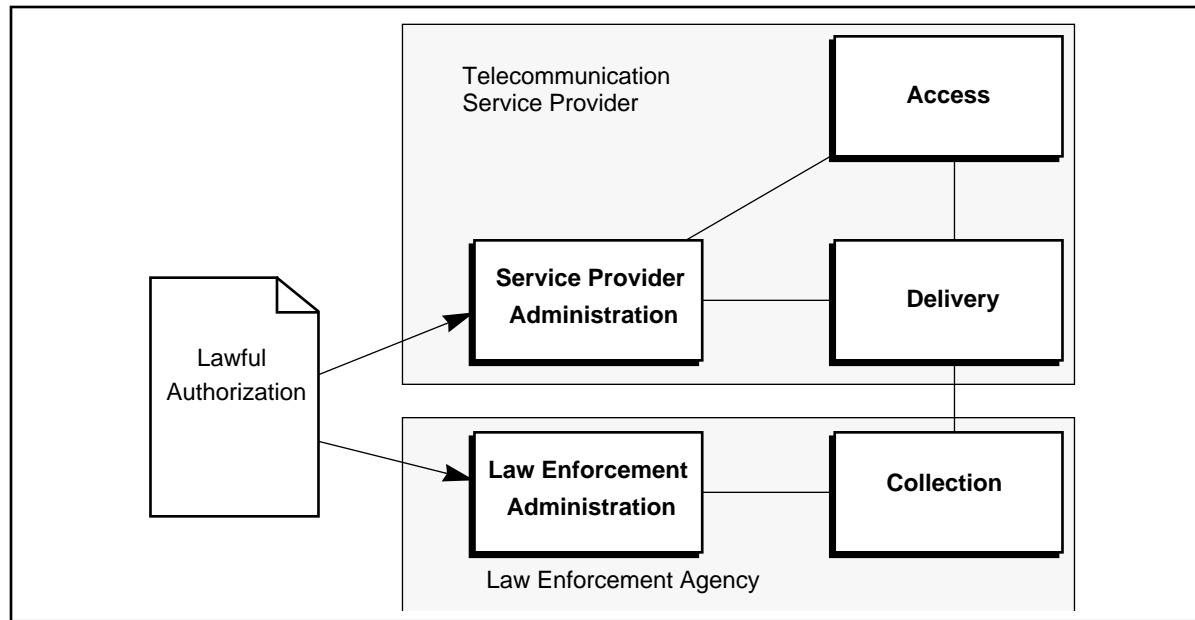

Figure 1: Electronic Surveillance Model

information unobtrusively. The IAPs may vary between TSPs and may not be available on all systems.

To address the requirements in FCC 99-230, CC Docket No. 97-213, new IAPs have been defined (i.e., Intercept Subject Signaling, Network Signaling, Conference Circuit). In general, these IAPs indicate new, additional intercept functionality, and not specific implementations. Vendor and TSP implementations may satisfy these requirements by consolidating the various IAP functionalities.

The Delivery Function is responsible for delivering intercepted communications to one or more Collection Functions. The Delivery Function delivers information over two distinct types of channels: Call Content Channels (CCCs) and Call Data Channels (CDCs). The CCCs are generally used to transport call content, such as voice or data communications. The CDCs are generally used to transport messages which report call-identifying information, such as the calling party identities and called party identities.

The Collection Function is responsible for collecting and analyzing intercepted communications and call-identifying information. The Collection Function is the responsibility of the LEA. It is assumed that the LEA collection equipment maintains current state information concerning the associations between call identities and party identities and between call identities and CCC identities based on the messages delivered to the Collection Function. The collection equipment assumes that the last reported association remains in effect until a subsequent LAES message explicitly changes that association.

The Service Provider Administration Function is responsible for controlling the TSP Access and Delivery Functions.

PN-4465-RV1

1
2
3
4
5
6
7
8
9
10
11
12
13
14
15
16
17
18
19
20
21
22
23
24
25
26
27
28
29
30
31
32
33
34
35
36
37
38
39
40
41
42
43
44
45
46
47
48
49
50
51
52
53
54
55
56
57
58
59

1 The Law Enforcement Administration Function is responsible for controlling
2 the LEA Collection Function. The Law Enforcement Administration
3 Function is the responsibility of the LEA.
4

5
6 The lawful authorization, while neither a network entity nor an interface
7 reference point, is an important part of LAES. No intercepts shall take place
8 without specific lawful authorization.
9

10 **4.2.3 Call Content Channels and Call Data Channels**

11
12 A TSP is required to provide access to the communications and call-identi-
13 fying information for particular intercept subjects.
14

15
16 A subject's call content is generally transported to the LEA over one or more
17 CCCs. The actual number of CCCs will vary with each electronic surveil-
18 lance according to the number of CCCs ordered by the LEA. Factors influ-
19 encing this number are the subject's bearer capabilities, the subject's call
20 capabilities, the type of communication being intercepted, the type and
21 capacity of individual CCCs, the number of possible call appearances, and the
22 subject's call-related activities. CCCs shall be provisioned as *combined* (i.e.,
23 carrying both the transmit and receive paths on one channel) or *separated*
24 (i.e., using independent channels for the transmit and receive paths). Each
25 CCC for an electronic surveillance must be capable of transporting one or
26 more of the subject's intercepted bearer services. For some types of applica-
27 tions used by the subject (e.g., short message service), the call content may be
28 transported over the CDC.
29

30
31 Additional CCCs shall be used (up to the number provisioned for a particular
32 electronic surveillance) when the CCCs currently open are incompatible with
33 the bearer services being intercepted. An example of this situation could be
34 when a subject initiates a voice call, optionally places that call on hold, and
35 initiates a second call using a different bearer service (e.g., fax or data).
36

37
38 The type of CCC delivered to an LEA may be influenced by the subject's
39 bearer services, the manner in which the subject's call content is accessed, the
40 preferences of the TSP, and the preferences of the LEA conducting the
41 electronic surveillance. Communications that inherently use separate
42 transmit and receive communications paths require separated CCCs. Other
43 communications inherently combine the transmit and receive paths (or
44 assume that the paths may be combined), so combined CCCs may be appro-
45 priate.
46

47
48 Call-identifying information is formatted into discrete messages using a
49 specialized protocol called the Lawfully Authorized Electronic Surveillance
50 Protocol (LAESP). The LAESP messages shall be transported to an LEA over
51 a CDC. As defined in this Interim Standard, a single CDC may support the
52 delivery of LAESP messages for one or more electronic surveillances to a
53 particular LEA collection facility.
54
55
56
57
58
59

PN-4465-RV1

The CDCs and CCCs shall use separate logical channels as shown in Figure 2. The CDC and CCC(s) may be transported to an LEA over separate or common physical facilities. The CDCs may be multiplexed onto one or more physical facilities.

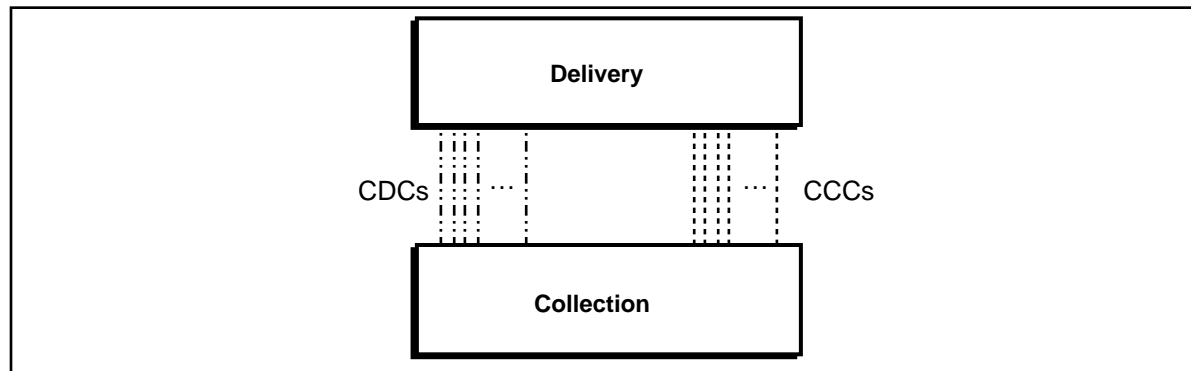

Figure 2: Call Content Channels and Call Data Channels

Rare circumstances dictate that the call-identifying information, call content, or both, associated with a particular subject need to be delivered to more than one LEA Collection Function simultaneously. This will occur when different LEAs are conducting independent investigations on the same subject. The Delivery Function shall duplicate the call content, call-identifying information, or both, and deliver only authorized information. No more than five Collection Functions are required to be supported for any single intercept subject. Separate circuits should be used to deliver the call content and call-identifying information to each LEA. The delivery options may be different for each path between an Access Function and a Collection Function.

Each CCC has a unique identity that is mutually agreed upon by the TSP and the LEA. The identity may be for a particular dedicated nailed up circuit, a dynamically allocated trunk member, or a directory number used for a switched connection. Each CCC may use a variety of physical implementations between the TSP and the LEA, but each CCC shall be uniquely identified.

4.3 Non-Call Associated Information Surveillance Service Description—Serving System IAP

Non-call associated information surveillance services access information within telecommunication systems. Information may be retrieved from existing messages and signaling or it may be derived from other information.

The Serving System Identification IAP (SSIAP) is the only non-call associated information IAP identified. The SSIAP shall report with a ServingSystem message the identification of the TSP providing service to a subject using a terminal or personal mobility service.

The serving system identification information includes the identity of the current system assigned to provide service for the mobile. Information regarding the occurrence of the event (e.g., identification of the system

PN-4465-RV1

1
2
3
4
5
6
7
8
9
10
11
12
13
14
15
16
17
18
19
20
21
22
23
24
25
26
27
28
29
30
31
32
33
34
35
36
37
38
39
40
41
42
43
44
45
46
47
48
49
50
51
52
53
54
55
56
57
58
59

providing the intercept access, time, date) should be included. In some situations the Serving System may be identified with a directory number (e.g., when a mobile station registers to a personal base station).

In J-STD-025A, SSIAP is one of the non-call associated information IAPs identified. See section 4.5 “Call Associated and Non-Call Associated Information Surveillance Service Description” on page 22.

4.4 Call Associated Information Surveillance Service Description—Call-Identifying Information IAP

4.4.1 Introduction

Call associated information surveillance services access information pertaining to call and service processing. This may span several functional entities.

The Call-Identifying Information IAP (IDIAP) is the only call associated information IAP identified. It provides expeditious access to the reasonably available call-identifying information for calls made by an intercept subject or for calls made to an intercept subject. This includes abandoned and incomplete call attempts and calls that are redirected (e.g., diverted, forwarded, or deflected) by the intercept subject’s equipment, facilities, or services.

A call event is a user action or signal that may cause a call state change. These events are not intended to reflect a particular technology, but to describe the event in general.

The IAP shall access the call-identifying information for the intercept subject unobtrusively. Access to call-identifying information shall not deny the availability of any service to either the subject or associates.

In J-STD-025A, the IDIAP is one of the call-identifying IAPs identified. See section 4.5 “Call Associated and Non-Call Associated Information Surveillance Service Description” on page 22

4.4.2 Basic Circuit Calls

The following call events are defined for circuit-mode calls only:

Answer

A party has answered the call attempt.

Change

The identity(ies) of a call has been merged with the identity(ies) of other call(s) or split into multiple call identities.

PN-4465-RV1

Origination

The system has routed a call dialed by the subject or the system has translated a number for the subject.

Redirection

A call has been redirected (e.g., forwarded, diverted, or deflected).

Release

The facilities for the entire call have been released.

TerminationAttempt

A call attempt to an intercept subject has been detected.

4.4.3 Conference Call Party Changes

With respect to the matters before the FCC in FCC 99-230, CC Docket No. 97-213, the following has been added to this Interim Standard:

The IDIAP provides conference call party change call-identifying information through the Party Hold, Join, Drop On Conference Calls service. This service permits an LEA to identify the parties to a subject-initiated conference call conversation at all times. The Party Hold, Join, Drop On Conference Calls capability is not required for two-party calls.

The IDIAP shall provide conference call party change call-identifying information of intercept subject calls to an On-demand Multi-Party (i.e., Meet Me) conference bridge, as it would be presented to the intercept subject (i.e., in a two-way communication) because no network signal would be generated to indicate intercept subject access and control of the conference feature.

4.5 Call Associated and Non-Call Associated Information Surveillance Service Description

4.5.1 Introduction

The Intercept Subject Signaling IAP (ISSIAP) and the Network Signaling IAP (NSIAP) provide access to call and non-call associated information surveillance services within a telecommunications system. They provide expeditious access to call and non-call associated signaling information. The ISSIAP provides access to intercept subject-initiated dialing and signaling information used to access features and services in a call or non-call associated form, including post cut-through digits dialed by the subject when a call is connected to another TSP's service for processing and routing. The NSIAP provides access to call-identifying network signaling information sent by the IAP to the subject to apply network signals (e.g., busy tone, reorder tone, call waiting tone).

PN-4465-RV1

1
2
3
4
5
6
7
8
9
10
11
12
13
14
15
16
17
18
19
20
21
22
23
24
25
26
27
28
29
30
31
32
33
34
35
36
37
38
39
40
41
42
43
44
45
46
47
48
49
50
51
52
53
54
55
56
57
58
59

The IAPs shall continue to access the signaling information for the intercept subject unobtrusively. Access to signaling information shall not deny the availability of any service to either the subject or associates.

4.5.2 Intercept Subject Signaling IAP

The following two subsections define call or non-call associated events for circuit-mode communications only.

4.5.2.1 Subject-initiated Dialing and Signaling

With respect to the matters before the FCC in FCC 99-230, CC Docket No. 97-213, the following has been added to this Interim Standard:

This service permits an LEA to be informed when a subject using the facilities under surveillance uses services that provide call-identifying information, such as call forwarding, call waiting, call hold, and three-way calling. It excludes signals generated by customer premises equipment when no network signal is generated.

4.5.2.2 Dialed Digit Extraction

With respect to the matters before the FCC in FCC 99-230, CC Docket No. 97-213, the following has been added to this Interim Standard:

This service permits an LEA to receive, on the call data channel, digits dialed by a subject when a call is connected to another TSP's service for processing and routing. However, this service does not require a TSP to assure that a connection is with another TSP's service.

4.5.3 Network Signaling IAP

The following subsection defines call or non-call associated events for circuit-mode communications only.

4.5.3.1 In-band and Out-of-band Signaling

With respect to the matters before the FCC in FCC 99-230, CC Docket No. 97-213, the following has been added to this Interim Standard:

This service permits an LEA to be informed when a network message that provides call-identifying information (e.g., busy, reorder, ringing, alerting, message waiting tone or visual indication, call waiting, calling or redirecting name/number information, displayed text) is generated or sent by the IAP switch to a subject using the facilities under surveillance. It excludes signals generated by customer premises equipment when no network signal is generated.

4.6 Content Surveillance Service Description

The IAPs for content surveillance are used to access the communications of an intercept subject. The content extracted by a content surveillance IAP shall

PN-4465-RV1

be delivered over a CCC or CDC. The IAPs may be dynamically added or dropped as necessary to access the communications of the intercept subject.

The following categories of content IAPs have been defined (for a discussion of circuit-mode vs. packet-mode see Annex B.1):

- Circuit IAP;
- Conference Circuit IAP; and
- Packet Data IAP.

The IAPs for content surveillance shall access the transmissions to and from the intercept subject unobtrusively. Access to call content shall not deny the availability of any service to either the subject or associates.

Content surveillance services provide access to calls at the IAP. Abandoned or incomplete calls may also be accessed.

A TSP shall not be responsible for decrypting, or ensuring the government’s ability to decrypt, any communication encrypted by a subscriber or customer, unless the encryption was provided by the TSP and the TSP possesses the information necessary to decrypt the communication.

The call-identifying information associated with the circuit-mode content surveillance is provided on the CDC by an IDIAP.

4.6.1 Circuit IAP

The Circuit IAP (CIAP) shall access the call content of circuit-mode communications to or from the equipment, facilities, or services of an intercept subject. This may include incoming calls to an intercept subject before they are answered and calls to an intercept subject that are redirected to another party. Loss of any portion (i.e., the beginning, middle, or end) of call content should not occur between call completion (answer) and call release. Call content may be delivered before answer and may include call progress tones or announcement.

Multiple CIAPs may be necessary for intercept subjects with multiple terminals or for terminals or services supporting multiple call appearances.

An idle CCC shall be selected from the CCCs available for this intercept subject and the selected destination. The selection criteria should use all CCCs on a regular basis.

PN-4465-RV1

1
2
3
4
5
6
7
8
9
10
11
12
13
14
15
16
17
18
19
20
21
22
23
24
25
26
27
28
29
30
31
32
33
34
35
36
37
38
39
40
41
42
43
44
45
46
47
48
49
50
51
52
53
54
55
56
57
58
59

Figure 3 shows the basic CIAP to access a two-way communication.¹

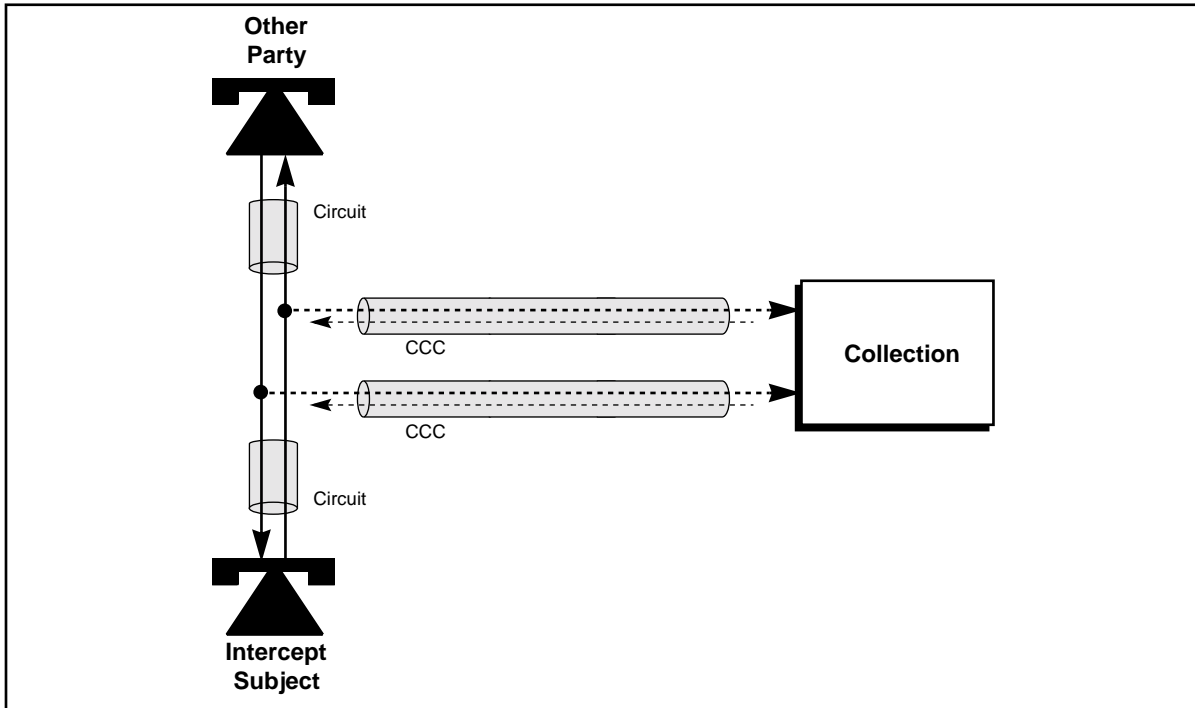

Figure 3: Circuit IAP for a Two-Way Communication

1. The symbols used in Figure 3 represent generic telecommunication terminals and services. The symbols should not be taken to exclude any particular technology.

PN-4465-RV1

The Circuit IAP (CIAP) shall access a multi-party circuit-mode communication (e.g., Three-Way Calling, Conference Calling, or Meet Me Conferences) as it would be presented to the intercept subject. This is depicted in Figure 4.¹

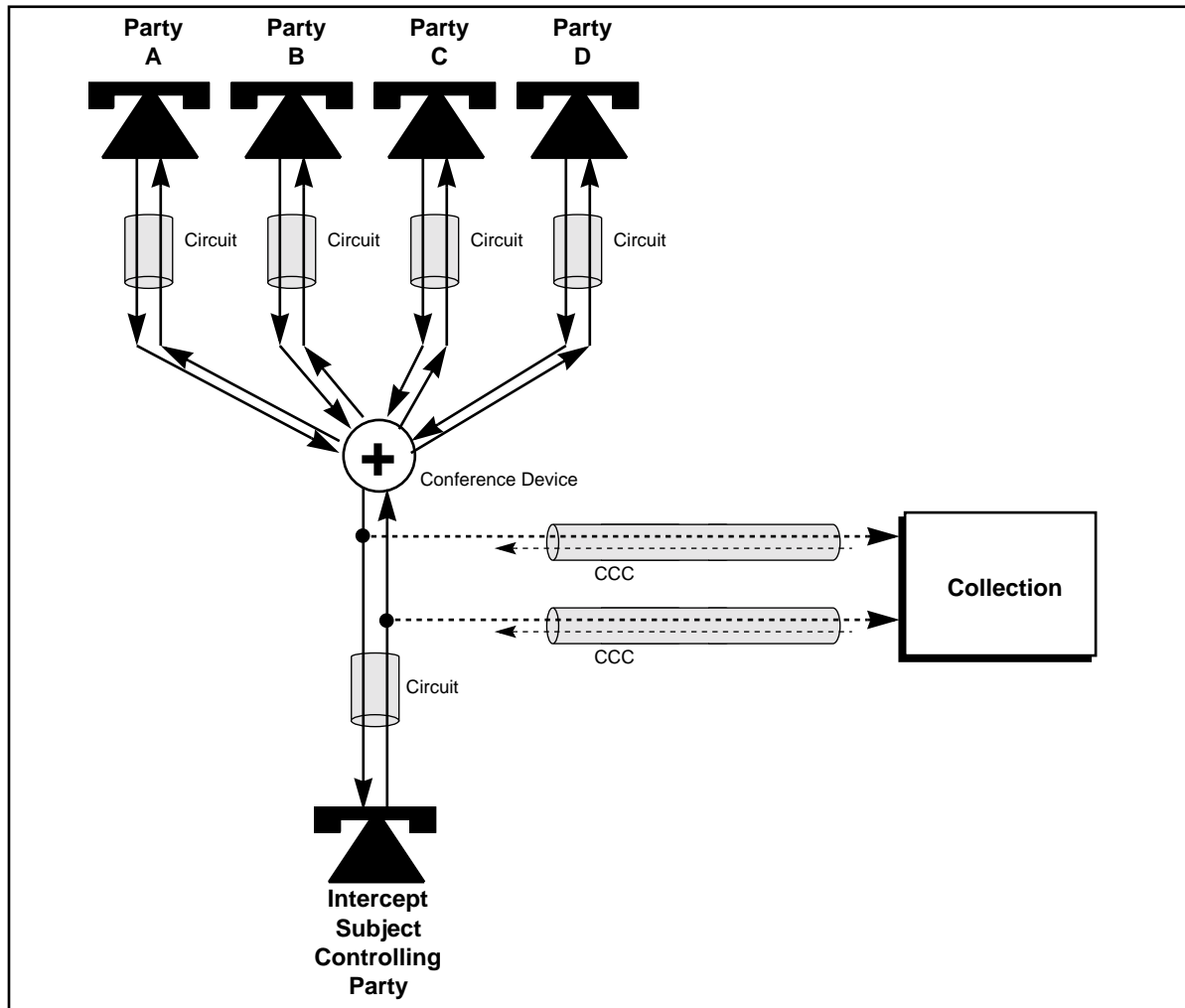

Figure 4: Circuit IAP for a Multi-Party Communication

In J-STD-025A, the Circuit IAP (CIAP) shall access the call content of On-demand Multi-Party (i.e., Meet Me Conference) circuit-mode communications as it would be presented to the intercept subject (i.e., two-way communication) because no network signal would be generated to indicate intercept subject access and control of the conference feature. Otherwise, Meet Me Conference calls are outside the scope of this standard. Figure 4 (above) depicts how a CIAP may access the call content of multi-party circuit-mode communications.

1. The symbols used in Figure 4 represent generic telecommunication terminals and services. The symbols should not be taken to exclude any particular technology.

PN-4465-RV1

1
2
3
4
5
6
7
8
9
10
11
12
13
14
15
16
17
18
19
20
21
22
23
24
25
26
27
28
29
30
31
32
33
34
35
36
37
38
39
40
41
42
43
44
45
46
47
48
49
50
51
52
53
54
55
56
57
58
59

The CIAP may access a call to the intercept subject before the intercept subject answers, as shown in Figure 5.¹ This may provide access to call progress tones or announcements played toward the calling party. Normally the calling party is not cut-through and is not accessible until the call is answered. This access may be independent of the intercept subject, in that the intercept subject may be engaged in other services or communicating with other parties while the incoming call is accessed.

If the call is answered by the network for user interaction; (e.g., to request a personal identification number (PIN), password, or extension number), both the transmit and receive communication paths should be accessed.

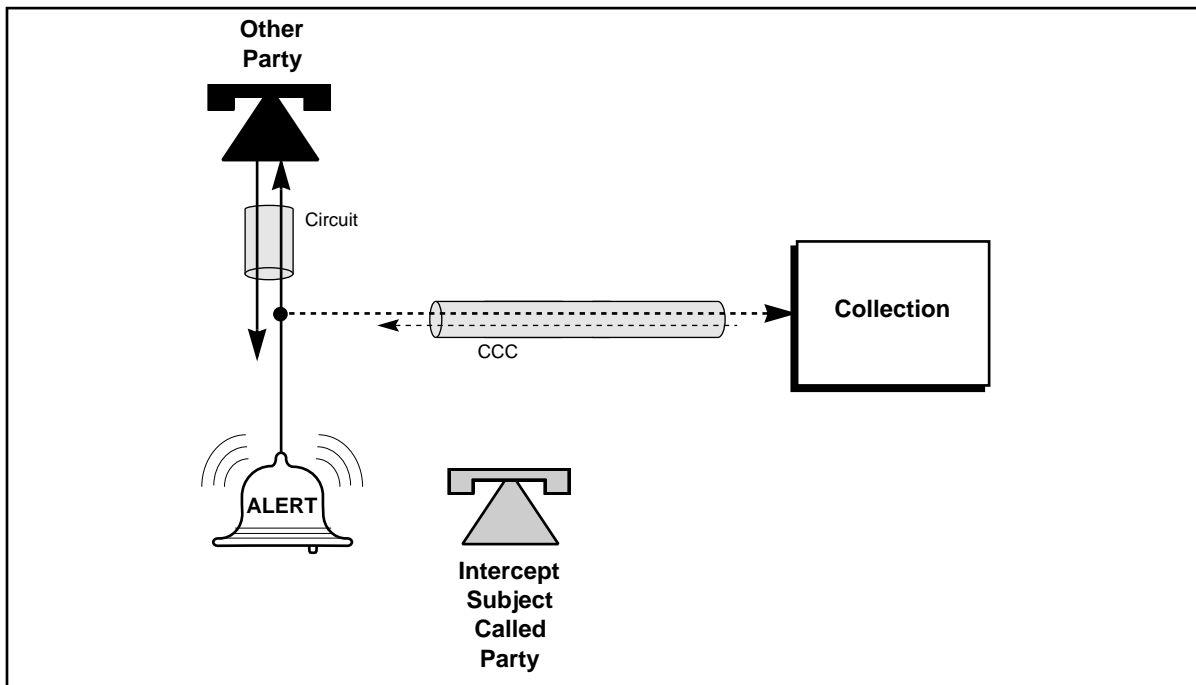

Figure 5: Circuit IAP for an Incoming Call

1. The symbols used in Figure 5 represent generic telecommunication terminals and services. The symbols should not be taken to exclude any particular technology.

The CIAP shall access a call redirected by the intercept subject. Redirection includes any rerouting of a call, for example, call delivery, call forwarding, call deflection, or call diversion. This access is independent of the intercept subject, as the intercept subject may engage in another communication or service at any time while a redirected call is in progress as shown in Figure 6.¹

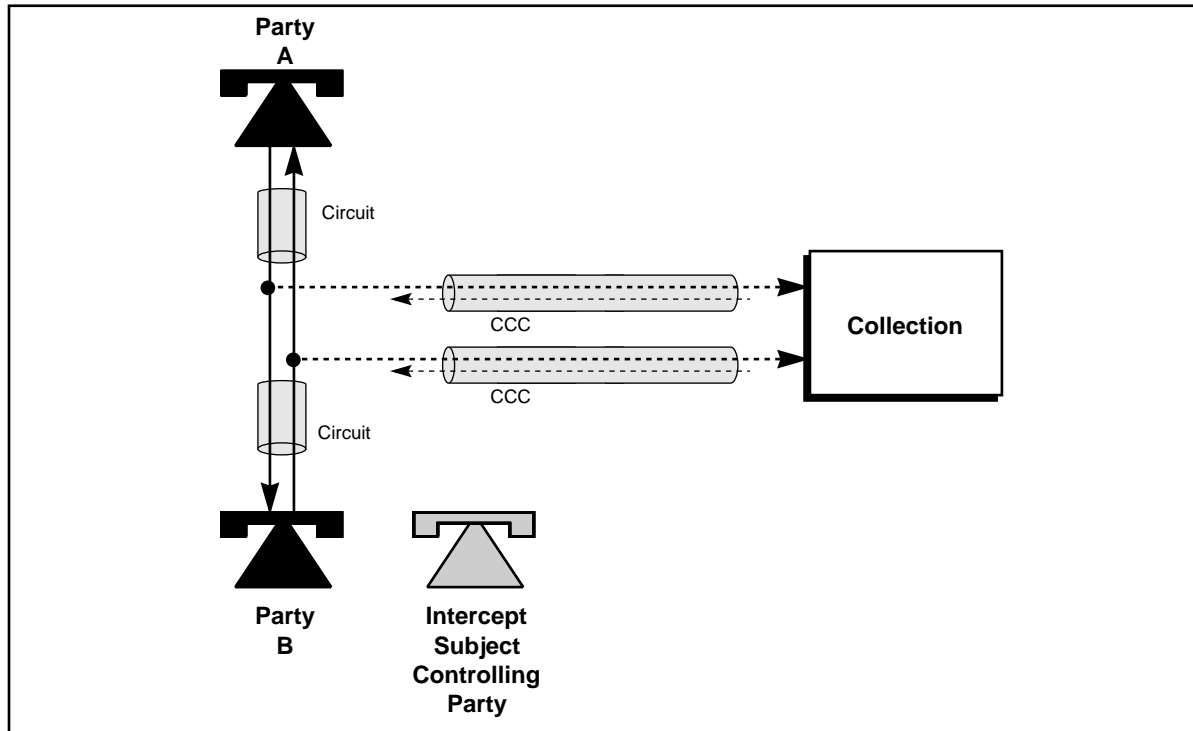

Figure 6: Circuit IAP for a Redirected Call

4.6.2 Conference Circuit IAP - Content of Subject-initiated Conference Calls

With respect to the matters before the FCC in FCC 99-230, CC Docket No. 97-213, the following has been added to this Interim Standard:

The Conference Circuit IAP (CCIAP) shall provide the Content of Subject-Initiated Conference Calls service (i.e., Three-Way Calling, Multi-Way Calling). This multi-party service permits an LEA to monitor the content of conversations by all parties connected to a subject-initiated conference call when the facilities under surveillance maintain a circuit connection to the call. The CCIAP shall continue to deliver content on subject-initiated multi-party conference calls when the subject has placed the conference call on hold. Call content for a single party on hold is not required to be delivered to law enforcement.

4.6.3 Packet Data IAP

A Packet Data IAP (PDIAP) shall access data packets sent or received by the equipment, facilities, or services of an intercept subject when a packet-mode

1. The symbols used in Figure 6 represent generic telecommunication terminals and services. The symbols should not be taken to exclude any particular technology.

PN-4465-RV1

1
2
3
4
5
6
7
8
9
10
11
12
13
14
15
16
17
18
19
20
21
22
23
24
25
26
27
28
29
30
31
32
33
34
35
36
37
38
39
40
41
42
43
44
45
46
47
48
49
50
51
52
53
54
55
56
57
58
59

1 data service is provided. PDIAPs may be on the Serving System or on the
2 Redirecting System. An IAP on the Redirecting System is only able to access
3 some packets delivered to the intercept subject (and possibly none of the
4 packets originated by the intercept subject).

5
6
7 If lawful interception is activated when a packet data service is already in use,
8 interception should be initiated expeditiously. If lawful interception is deacti-
9 ated during a packet data service, interception should be discontinued in an
10 expeditious manner.

11
12
13 Packets shall be sent to the Collection Function when they are intercepted.
14 The intercepted packets shall be delivered without interpretation or modifi-
15 cation, except for possible re-framing, segmentation, or enveloping required
16 to transport the information to the Collection Function or except to remove
17 information that is not authorized. A TSP shall not be responsible for inter-
18 preting the protocols beyond those protocols being processed by the TSP. A
19 TSP shall not be responsible for decrypting or decompressing, or ensuring the
20 government's ability to decrypt or decompress, any communication
21 encrypted or compressed by a subscriber or customer, unless the encryption
22 or compression was provided by the TSP and the TSP possesses the infor-
23 mation necessary to decrypt or decompress the communication. The access
24 includes all packet-mode data transmissions regardless of their outcome. For
25 example, when an SMS packet to a Mobile Station (MS) is intercepted, it is
26 not known whether the packet was actually received by the MS.
27

28
29
30 A Packet Data IAP (PDIAP) provides access to one or more of the following
31 packet-mode data services:

- 32 • ISDN user-to-user signaling;
 - 33 • ISDN D-channel X.25 packet services;
 - 34 • Short Message Services (SMS) for cellular and Personal Commu-
35 nication Services (e.g., NAMPS, TIA/EIA-41, PCS1900, or GSM-
36 based technologies);
 - 37 • wireless packet-mode data services (e.g., Cellular Digital Packet
38 Data (CDPD), CDMA, TDMA, PCS1900, or GSM-based packet-
39 mode data services);
 - 40 • X.25 services;
 - 41 • IP services;
 - 42 • paging (one-way or two-way); and
 - 43 • packet-mode data services using traffic channels.
- 44
45
46
47
48
49
50
51
52
53
54
55
56
57
58
59

Separated CCCs may be used to transport packet data to the Collection Function as shown in Figure 7.¹

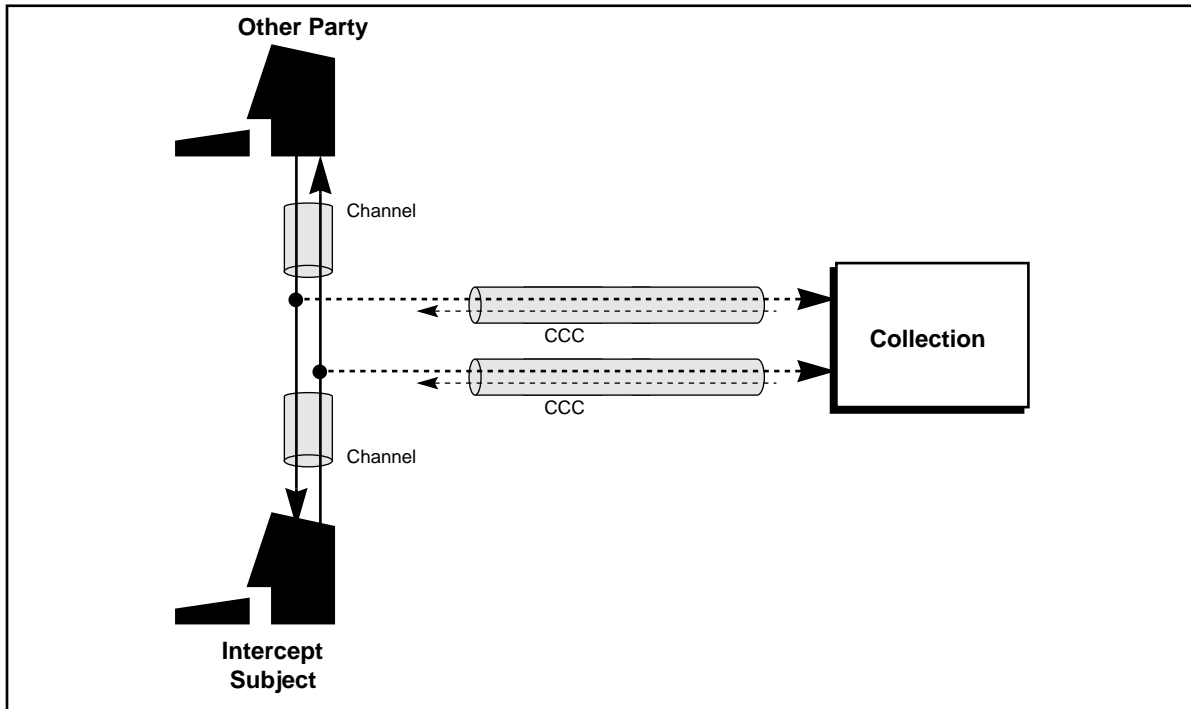

Figure 7: Packet Data IAP to a Separated CCC (appropriate to all data services)

1. The symbols used in Figure 7 represent generic telecommunication terminals and services. The symbols should not be taken to exclude any particular technology.

PN-4465-RV1

1
2
3
4
5
6
7
8
9
10
11
12
13
14
15
16
17
18
19
20
21
22
23
24
25
26
27
28
29
30
31
32
33
34
35
36
37
38
39
40
41
42
43
44
45
46
47
48
49
50
51
52
53
54
55
56
57
58
59

1 Connectionless data services may use separated delivery as shown above or
2 they may use combined delivery as depicted in Figure 8.¹
3
4

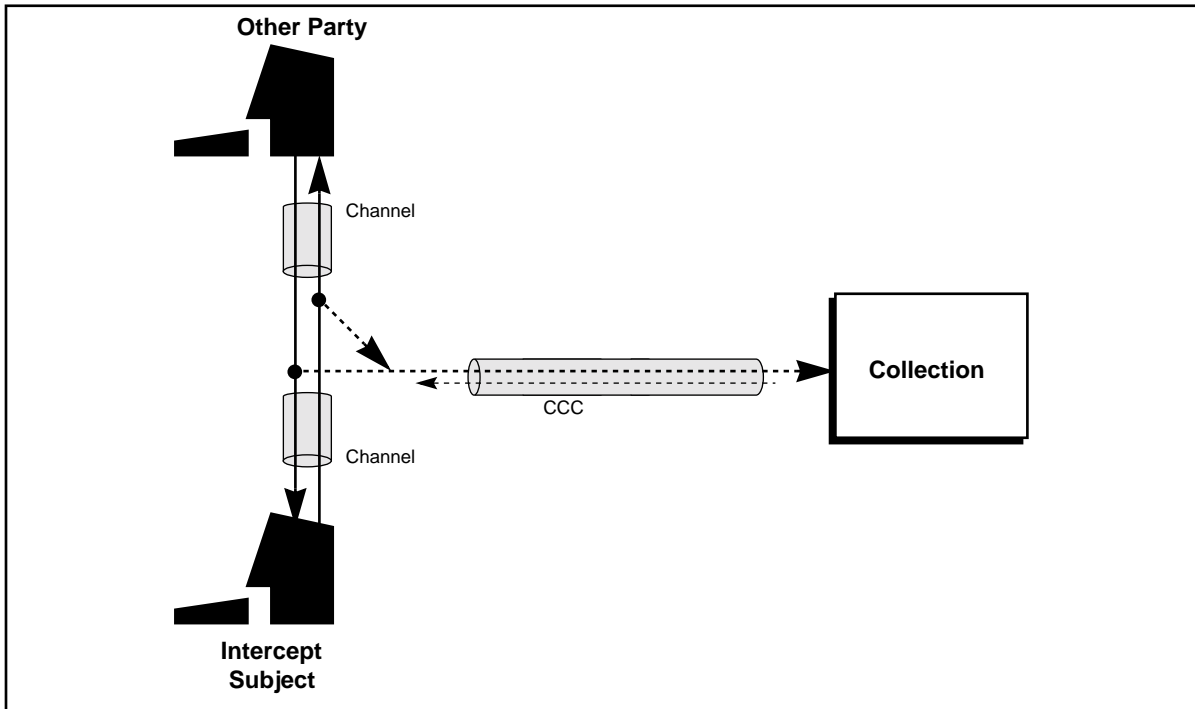

5
6
7
8
9
10
11
12
13
14
15
16
17
18
19
20
21
22
23
24
25
26
27
28
29 **Figure 8: Packet Data IAP to a Combined CCC (connectionless data services only)**

30
31
32
33
34
35
36
37
38
39
40
41
42
43
44
45
46
47
48
49
50
51
52
53
54
55
56
57
58
59

1. The symbols used in Figure 8 represent generic telecommunication terminals and services. The symbols should not be taken to exclude any particular technology.

PN-4465-RV1

Certain intercepted packets may be delivered over a CDC using PacketEnvelope messages as shown in Figure 9.¹

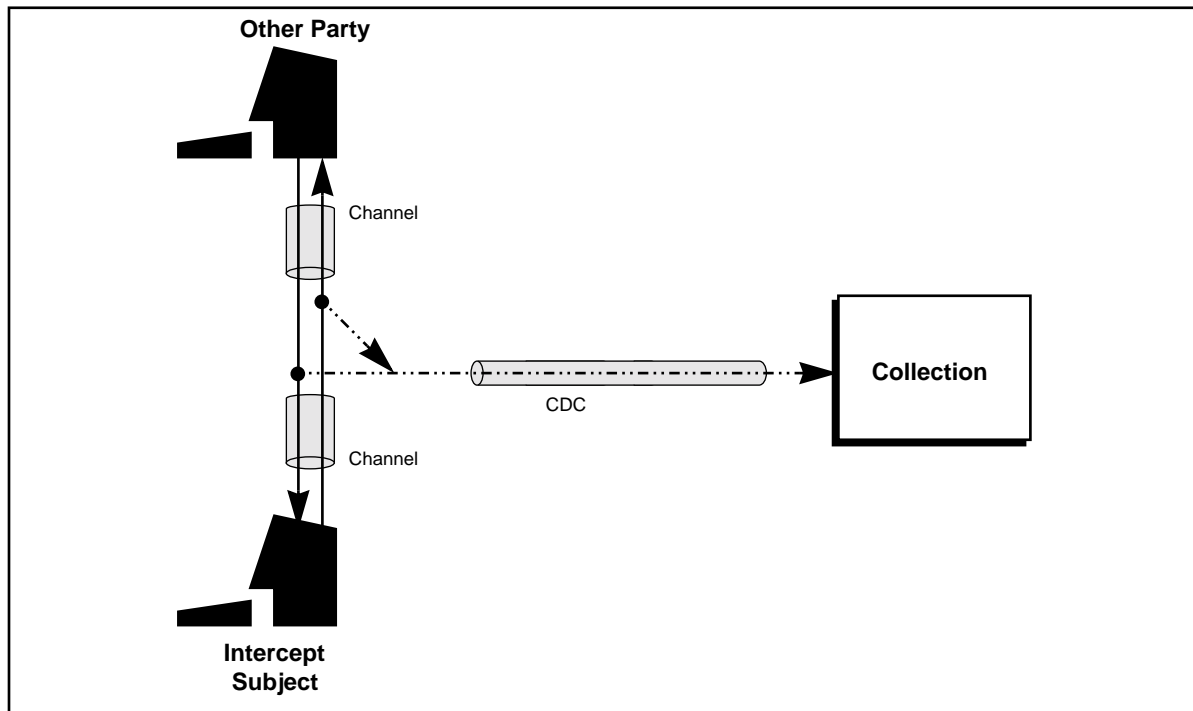

Figure 9: Packet Data IAP to a CDC (for selected packet types)

4.7 Timing Information

With respect to the matters before the FCC in FCC 99-230, CC Docket No. 97-213, the following has been added to this Interim Standard:

This capability permits an LEA to associate call-identifying information with the content of a call. A call-identifying message must be sent from the TSP's IAP to the LEA Collection Function within eight seconds of receipt of that message by the IAP at least 95% of the time, and with the call event time-stamped to an accuracy of at least 200 milliseconds.

This capability places timing requirements on call-identifying message generation after triggering events that shall be met for these messages. It also requires time stamp accuracy for call events.

1. The symbols used in Figure 9 represent generic telecommunication terminals and services. The symbols should not be taken to exclude any particular technology.

PN-4465-RV1

1
2
3
4
5
6
7
8
9
10
11
12
13
14
15
16
17
18
19
20
21
22
23
24
25
26
27
28
29
30
31
32
33
34
35
36
37
38
39
40
41
42
43
44
45
46
47
48
49
50
51
52
53
54
55
56
57
58
59

4.8 Restrictions

4.8.1 Lack of CDC and CCC Synchronization

The CDC and CCC information will not necessarily be synchronized when received by an LEA. The call content and call-identifying information are delivered to an LEA using the independent services of the CCCs and CDCs respectively, and these services can be provided on independent networks (e.g., dedicated circuits for the CCC and switched packet network delivery for the CDC).

4.8.2 CDC Congestion

When the call-identifying information intercept communication resources (e.g., CDCs) are limited, the communications are accessed on a first-in, first-out, non-queued basis. If a particular CDC is congested and the associated buffers (if any) are full, messages destined to that CDC may be discarded by the originating end. Unavailability or congestion of a CDC shall not affect other CCCs or CDCs.

4.8.3 CCC Exhaustion

When the call content intercept communication resources (e.g., CCCs) are limited, the communications are accessed on a first-come, first-served, non-queued basis. In other words, CCCs are assigned as they are needed. If a CCC is needed and none is available, that request is ignored, even if a CCC should subsequently become available during the communication pertaining to that request. The CCC may remain unused until the next request for a CCC for the subject is received. Unavailability of a CCC shall not affect other CCCs or CDCs.

Channels dedicated to a particular subject shall not be used for other subjects.

4.8.4 CCC Congestion

For CCCs used for packet-mode delivery, the bandwidth available depends upon the communication facilities and also upon concurrent traffic. If a packet-mode CCC toward the Collection Function becomes congested, intercepted packets may be discarded. Congestion of a CCC shall not affect other CCCs or CDCs.

4.9 Packet Mode Technology

Packet Data LAES service shall provide the following interception functions:

- call-identifying information only;
- Both call content and call-identifying information.

[editors note matrix may be added later to map terminology between different technologies.]

4.9.1 CDMA2000 Packet Data

This section defines an interception service for a CDMA2000 packet data system. The LAES service in a CDMA2000 system supports the standard LAES reference model.(reference section added here).

4.9.1.1 General Principles

For interception, there needs to be a means of identifying the intercept subject and correspondent node of the communication. Intercept subject identities used for interception of packet data services shall be based on a mobile node's identity (e.g., IMSI, NAI, or assigned IP address). Correspondent nodes are identified by IP address.

[editor's note: further explanation of mobile node and correspondent node is forthcoming.]

4.9.1.2 Applicability to Telecommunications Services

The requirement for LAES service is that all telecommunications services using the CDMA2000 packet data standards should be capable of meeting the requirements within this section.

[editor's note: 4.9.2, 4.9.3 are examples of level three headings that will be used for other packet mode technologies.]

4.9.2 Packet Technology B

4.9.3 Packet Technology C

PN-4465-RV1

1
2
3
4
5
6
7
8
9
10
11
12
13
14
15
16
17
18
19
20
21
22
23
24
25
26
27
28
29
30
31
32
33
34
35
36
37
38
39
40
41
42
43
44
45
46
47
48
49
50
51
52
53
54
55
56
57
58
59

5 Stage 2 Description: Network Perspective

5.1 Introduction

This section describes the information flows between the Access, Delivery, and Collection Functions to support LAES. The information flows are usually described as messages and information carried by a message.

5.2 Stage 2 Methodology

This section describes the methodology and organization for the development of the Stage 2 network perspective descriptions. A network reference model is developed and then information flows between functional entities over reference points are described.

Information is described in terms of a causing event and information associated with that event. Within each service description there is a set of events to support the particular service and a data dictionary to define a set of information elements to support the events.

Stage 2 for LAES CDCs deals with the movement of information between the Access, Delivery, and Collection Functions. The CDC Stage 2 description focuses on the information being transferred, rather than the transfer mechanism.

CCCs shall be delivered to LEAs using protocols as specified in [Section 6.5](#).

1
2
3
4
5
6
7
8
9
10
11
12
13
14
15
16
17
18
19
20
21
22
23
24
25
26
27
28
29
30
31
32
33
34
35
36
37
38
39
40
41
42
43
44
45
46
47
48
49
50
51
52
53
54
55
56
57
58
59

PN-4465-RV1

5.3 Network Reference Model

The Network Reference model, as shown in Figure 10, consists of a set of functional entities and interface reference points between some of those functional entities. The functional entities provide the functions of the system, and an interface reference point allows information to be exchanged between the two functional entities connected by the interface reference point.

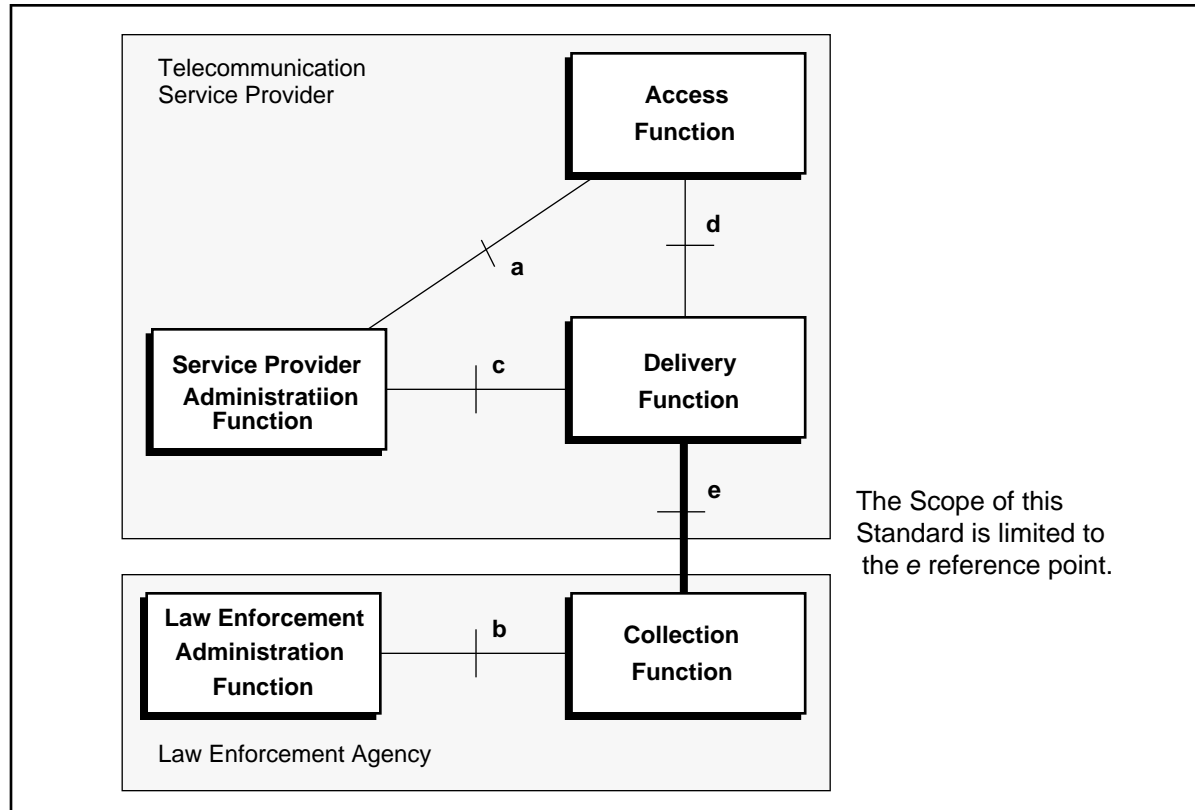

Figure 10: Network Reference Model

PN-4465-RV1

1
2
3
4
5
6
7
8
9
10
11
12
13
14
15
16
17
18
19
20
21
22
23
24
25
26
27
28
29
30
31
32
33
34
35
36
37
38
39
40
41
42
43
44
45
46
47
48
49
50
51
52
53
54
55
56
57
58
59

5.3.1 Functional Entities

5.3.1.1 Access Function (AF)

The Access Function, through its constituent Intercept Access Points (IAPs), is responsible for providing access to an intercept subject's communications, call-identifying information, or both.

The Access Function typically includes the ability:

- to access intercept subject's call-identifying information unobtrusively and make the information available to the Delivery Function;
- to access intercept subject call content unobtrusively and make the call content available to the Delivery Function; and
- to protect (e.g., prevent unauthorized access, manipulation, and disclosure) intercept controls, intercepted call content and call-identifying information consistent with TSP security policies and practices.

5.3.1.2 Delivery Function (DF)

The Delivery Function is responsible for delivering intercepted communications and call-identifying information to one or more Collection Functions.

The Delivery Function typically includes the ability:

- to accept call content for each intercept subject over one or more channels from the Access Function(s);
- to deliver call content for each intercept subject over one or more CCCs to a Collection Function;
- to accept call-identifying or packet-mode content information for each intercept subject over one or more channels and deliver that information to the Collection Function over one or more CDCs;
- to ensure that the call-identifying information and call content delivered to a Collection Function is authorized for a particular LEA;
- to duplicate and deliver authorized call-identifying information and content for the intercept subject to one or more Collection Functions (up to a total of five); and
- to protect (e.g., prevent unauthorized access, manipulation, and disclosure) intercept controls, intercepted call content and call-identifying information consistent with TSP security policies and practices.

PN-4465-RV1

5.3.1.3 Collection Function (CF)

The Collection Function is responsible for collecting lawfully authorized intercepted communications (i.e., call content) and call-identifying information for an LEA. The Collection Function is the responsibility of the LEA.

The Collection Function typically includes the ability:

- to receive and process call content information for each intercept subject; and
- to receive and process information regarding each intercept subject (e.g., call associated or non-call associated).

5.3.1.4 Service Provider Administration Function (SPAF)

The Service Provider Administration Function is responsible for controlling TSP electronic surveillance functions.

The functions of the SPAF are beyond the scope of this Interim Standard.

5.3.1.5 Law Enforcement Administration Function (LEAF)

The Law Enforcement Administration Function is responsible for controlling LEA electronic surveillance functions. The Law Enforcement Administration Function is the responsibility of the LEA.

The functions of the LEAF are beyond the scope of this Interim Standard.

5.3.2 Interface Reference Points

5.3.2.1 Reference Point *a*

Reference point *a*, or the *a*-interface, is the interface between the Service Provider Administration Function and the Access Function.

Reference point *a* is beyond the scope of this Interim Standard.¹

5.3.2.2 Reference Point *b*

Reference point *b*, or the *b*-interface, is the interface between the Law Enforcement Administration Function and the Collection Function.

Reference point *b* is beyond the scope of this Interim Standard.

1. This reference point is required to protect (e.g., prevent unauthorized access, manipulation, and disclosure) 1) the privacy and security of communications and call-identifying information not authorized to be intercepted; and 2) information regarding the government's interception of communications and access to call-identifying information.

5.3.2.3 Reference Point *c*

Reference point *c*, or the *c*-interface, is the interface between the Service Provider Administration Function and the Delivery Function.

Reference point *c* is beyond the scope of this Interim Standard.¹

5.3.2.4 Reference Point *d*

Reference point *d*, or the *d*-interface, is the interface between the Access Function and the Delivery Function.

Reference point *d* is beyond the scope of this Interim Standard.¹

5.3.2.5 Reference Point *e*

Reference point *e*, or the *e*-interface, is the interface between the Delivery Function and the Collection Function.

Reference point *e* is defined by this Interim Standard.¹

5.4 Message Descriptions

The call events described in Stage 1 convey the basic information for reporting the disposition of a call. This section describes those events and supporting information.

Each message is described as consisting of a set of parameters. Each parameter is either:

- mandatory (M)—required for the message,
- conditional (C)—required in situations where a condition (defined in the usage column of the table where it occurs) is met, or
- optional (O)—provided at the discretion of the implementation.

The information to be carried by each parameter is identified. Please note that both optional and conditional parameters at Stage 2 are considered to be OPTIONAL syntactically in ASN.1 Stage 3 descriptions. The Stage 2 inclusion requirements take precedence over the Stage 3 syntax.

1. This reference point is required to protect (e.g., prevent unauthorized access, manipulation, and disclosure) 1) the privacy and security of communications and call-identifying information not authorized to be intercepted; and 2) information regarding the government's interception of communications and access to call-identifying information.

5.4.1 Answer

The Answer message reports when a circuit-mode call or call leg has been answered. Transmission is usually cut-through in both directions to the intercept subject or its agent.

The Answer message shall be triggered when:

- the intercept subject answers a call or call leg that has not been previously answered by the intercept subject;
- an agent of the intercept subject (e.g., by voice mail or for password screening) answers a call or call leg;
- an associate answers an outgoing call from the intercept subject as detected by the accessing functional entity;
- a call redirected by the intercept subject is answered as detected by the accessing functional entity; or
- the intercept subject or its agent answers a recalling associate (e.g., hold recall, transfer recall, or attendant recall).

The Answer message includes the following parameters:

Table 1: Answer Message Parameters

Parameter	MOC	Usage
CaselfIdentity	M	Identifies the Intercept Subject.
IAPSystemIdentity	C	Included to identify the system containing the IAP when the underlying data carriage does not imply that system.
TimeStamp	M	Identifies the date and time that the event was detected.
CallIdentity	M	Uniquely identifies a call, call appearance, or call leg within a system.
Answering PartyIdentity	C	Include, when known, to identify the answering party or agent.
Location	C	Include, when a call terminating to the intercept subject's mobile terminal is answered, the location information is reasonably available at the IAP and delivery is authorized, to identify the location of an intercept subject's mobile terminal.
BearerCapability	C	Include, when known (or presumed), to indicate the granted bearer service.

See 6.3.1 "Answer Message" on page 64 for the Stage 3 description.

5.4.2 CCClose

The CCClose message reports the end of call content delivery.

The CCClose message shall be triggered when the CCC is released, such as when:

- the intercepted circuit-mode call is released;
- the intercepted circuit-mode call leg is released;
- the intercepted circuit-mode call is merged with another intercepted circuit-mode call; or
- the intercepted circuit-mode call leg is merged into another intercepted circuit-mode call.

The CCClose message may be triggered when:

- an early release of the circuit-mode or packet-mode CCC by the Collection Function or intervening network is detected (e.g., see [B.4.7](#));
- a delivery channel for packet data is no longer required;
- the monitored packet-mode call is released; or
- a conference call is retrieved from a hold condition.

One CCClose message is required for each delivered combined CCC, separated CCC pair, or individual CCC.

The CCClose message includes the following parameters:

Table 2: CCClose Message Parameters

Parameter	MOC	Usage
CaseIdentity	M	Identifies the Intercept Subject.
IAPSystemIdentity	C	Included to identify the system containing the IAP when the underlying data carriage does not imply that system.
TimeStamp	M	Identifies the date and time that the event was detected.
CCCIdentity	M	Identifies the CCC(s) used to deliver a particular call leg (e.g., a trunk identity, telephone number, or a data network address).

See 6.3.2 “CCClose Message” on page 65 for the Stage 3 description.

5.4.3 CCOpen

The CCOpen message associates a circuit-mode CCC with a particular call instance.

The CCOpen message shall be triggered when circuit-mode call content delivery begins. This should occur after a call is initiated (as an intercept subject origination or termination attempt), but prior to the cut-through of communications between the subject and associate (usually indicated with an answer).

The CCOpen message may be triggered when a conference call is placed on hold.

The CCOpen message may be triggered when a delivery CCC is required for packet-mode data. The CCOpen is required when intercepted packets are to be delivered over a circuit or over a packet switched data network. Packet-mode delivery uses a single packet data network service to deliver intercepted packets to a single address per Collection Function. Packet-mode delivery is differentiated from a circuit-mode intercept by including a **PDUType** parameter instead of a **CallIdentity** parameter. Circuit-mode delivery CCCs may deliver packet-mode content as identified by the **BearerCapability** parameter or by an agreement between the TSP and LEA.

One CCOpen message is required for each delivered combined CCC, separated CCC pair, or individual CCC.

Delivery of call content is dependent upon appropriate provisioning of call content channels.

1
2
3
4
5
6
7
8
9
10
11
12
13
14
15
16
17
18
19
20
21
22
23
24
25
26
27
28
29
30
31
32
33
34
35
36
37
38
39
40
41
42
43
44
45
46
47
48
49
50
51
52
53
54
55
56
57
58
59

PN-4465-RV1

The CCOpen message includes the following parameters:

Table 3: CCOpen Message Parameters

Parameter	MOC	Usage
CaseIdentity	M	Identifies the Intercept Subject.
IAPSystemIdentity	C	Included to identify the system containing the IAP when the underlying data carriage does not imply that system.
TimeStamp	M	Identifies the date and time that the event was detected.
ContentType One of: CallIdentity PDUType	M	Include for circuit-mode calls to identify a particular circuit-mode call for the CCC. A unique call identity may be generated for the CCOpen message which is used to correlate other messages with the delivered call content. Include for packet-mode calls to identify the type of packet data units being intercepted (e.g., IP, PPP, X.25 LAPB, ISDN D-channel).
CCCIdentity	M	Identifies the CCC(s) used to deliver a particular call leg (e.g., a trunk identity, telephone number, or a data network address).

See 6.3.3 “CCOpen Message” on page 65 for the Stage 3 description.

5.4.4 Change

The Change message reports a change in circuit-mode call identity(ies), especially when merging or splitting calls.

The Change message shall be triggered when:

- two or more call identities are merged into one call identity;
- an additional call identity is associated with an existing call,
- a call identity is split into two or more call identities; or
- a call identity is changed to another call identity.

The Change message includes the following parameters:

Table 4: Change Message Parameters

Parameter	MOC	Usage
Caselidentity	M	Identifies the Intercept Subject.
IAPSystemIdentity	C	Included to identify the system containing the IAP when the underlying data carriage does not imply that system.
TimeStamp	M	Identifies the date and time that the event was detected.
Previous Calls	M	Identifies all of the existing calls to be affected. Any call identity that is mentioned as a previous call identity, but is not mentioned as a resulting call identity is released and may be reassigned to other calls.
Resulting Calls	M	Identifies the CallIdentity(ies) and CCIdentity(ies) in each of the resulting calls. New unique call identities may be generated for the Change message which is used to correlate subsequent messages with the delivered call content.

See 6.3.4 “Change Message” on page 65 for the Stage 3 description.

5.4.5 ConferencePartyChange

The ConferencePartyChange message reports a change in circuit-mode call identity(ies), party identity(ies) or both when independently or in any combination reporting:

- a change in communicating parties;
- a previously communicating party(ies) is removed (e.g., hold service);
- a new party is joining the communicating parties; or
- a previously communicating party(ies) is dropped from the conference call.

The ConferencePartyChange message shall be triggered when there is a change in communicating parties, as:

- a new party joins the communicating parties;
- a previously communicating party(ies) is removed (e.g., hold service); or
- a previously communicating party(ies) or a removed party(ies) (e.g., hold service) is dropped from the conference call.

Whenever one or more CallIdentity(ies) are grouped together with one or more PartyIdentity(ies) and a CCCIdentity(ies), it means that all PartyIdentity(ies) are connected and communicating on the call represented by the group of CallIdentity(ies), and can be monitored (heard) on the CCCIdentity, with the exception of the removed or dropped groups.

In the RemovedIdentity(ies) or DroppedIdentity(ies) case, the grouping of PartyIdentity(ies) with a CallIdentity(ies) means that the identified PartyIdentity(ies) is disassociated with that CallIdentity(ies) and can not be monitored (heard) on the associated CCCIdentity.

Any CallIdentity(ies), PartyIdentity(ies), and CCCIdentity(ies) not connected to the same communications would be reported as separate groups within the CommunicatingIdentity(ies), RemovedIdentity(ies), or JoinedIdentity(ies).

This message shall not be used to open or close a CCC, to create a new call identity, or to release an existing call identity.

This message is not required when the information reported would be redundant with the information reported by other LAES call event messages.

PN-4465-RV1

The ConferencePartyChange message includes the following parameters:

Table 5: ConferencePartyChange Message Parameters

Parameter	MOC	Usage
CaseIdentity	M	Identifies the Intercept Subject.
IAPSystemIdentity	C	Included to identify the system containing the IAP when the underlying data carriage does not imply that system.
TimeStamp	M	Identifies the date and time that the event was detected.
CommunicatingIdentity(ies)	C	Included when known, to identify all communicating call identity(ies), party identity(ies), or both on the identified conference call established by the intercept subject's service. This parameter may appear independently or in combination with other parameters.
DroppedIdentity(ies)	C	Included when known, to identify a previously communicating call identity(ies), party identity(ies), or both on the identified conference call established by the intercept subject's service; the dropped identity(ies) is no longer participating in the call. This parameter may appear independently or in combination with other parameters.
RemovedIdentity(ies)	C	Included when known, to identify a previously communicating call identity(ies), party identity(ies), or both on the identified conference call established by the intercept subject's service; the identity(ies) is removed (e.g., hold service) from a call. This parameter may appear independently or in combination with other parameters.
JoinedIdentity(ies)	C	Included when known, to identify a new communicating call identity(ies), party identity(ies), or both on the identified conference call established by the intercept subject's service; the joined identity(ies) has begun communicating on the call. This parameter may appear independently or in combination with other parameters.

See 6.3.5 "ConferencePartyChange Message" on page 66 for the Stage 3 description.

PN-4465-RV1

1
2
3
4
5
6
7
8
9
10
11
12
13
14
15
16
17
18
19
20
21
22
23
24
25
26
27
28
29
30
31
32
33
34
35
36
37
38
39
40
41
42
43
44
45
46
47
48
49
50
51
52
53
54
55
56
57
58
59

5.4.6 Connection

The Connection message reports the addition of one or more participants to an existing call (i.e., a leg is connected to the call so that communications can occur). The Connection message reports the participants to a subject-initiated conference call.

The Connection message shall be triggered when:

- the intercept subject's service changes connections to allow participants to be added to a call under surveillance; or
- there are party hold, drop, join changes to a conference communication during a subject-initiated conference call.

This message, either alone or in combination with the ConnectionBreak message, can be used to satisfy the requirement to report the participants to a subject-initiated conference call. When the Connection message is used alone, it identifies all participants able to communicate with each other in a call.

This message is not required when the information reported would be redundant with the information reported by other LAES call event messages.

The Connection message includes the following parameters:

Table 6: Connection Message Parameters

Parameter	MOC	Usage
CaseIdentity	M	Identifies the Intercept Subject.
IAPSystemIdentity	C	Included to identify the system containing the IAP when the underlying data carriage does not imply that system.
TimeStamp	M	Identifies the date and time that the event was detected.
CallIdentity	M	Uniquely identifies a call, call appearance, or call leg within a system.
ConnectionInformation One or more of: ConnectedParties NewParties	M	Identifies parties able to communicate to each other in a call. Identifies one or more parties added to a call.

See 6.3.6 "Connection Message" on page 67 for the Stage 3 description.

5.4.7 ConnectionBreak

The ConnectionBreak message reports when one or more participants are removed from an existing call (i.e., a leg is removed from a call so that communications can not occur). The ConnectionBreak message reports when participants to a subject-initiated conference call are removed (e.g., temporarily or permanently).

The ConnectionBreak message shall be triggered when:

- the intercept subject’s service changes connections to remove participants from a call under surveillance; or
- there are party hold or drop changes to a conference communication during a subject-initiated conference call.

This message, in combination with the Connection message, can be used to satisfy the requirement to report the participants to a subject-initiated conference call.

This message is not required when the information reported would be redundant with the information reported by other LAES call event messages.

The ConnectionBreak message includes the following parameters:

Table 7: ConnectionBreak Message Parameters

Parameter	MOC	Usage
CaseIdentity	M	Identifies the Intercept Subject.
IAPSystemIdentity	C	Included to identify the system containing the IAP when the underlying data carriage does not imply that system.
TimeStamp	M	Identifies the date and time that the event was detected.
CallIdentity	M	Uniquely identifies a call, call appearance, or call leg within a system.
ConnectionBreakInformation One or more of: RemovedParties RemainingParties DroppedParties	M	Identifies parties removed (e.g., hold service) from a call. Identifies parties remaining in a call. Identifies parties permanently disconnected from a call.

See 6.3.7 “ConnectionBreak Message” on page 67 for the Stage 3 description.

PN-4465-RV1

1
2
3
4
5
6
7
8
9
10
11
12
13
14
15
16
17
18
19
20
21
22
23
24
25
26
27
28
29
30
31
32
33
34
35
36
37
38
39
40
41
42
43
44
45
46
47
48
49
50
51
52
53
54
55
56
57
58
59

5.4.8 DialedDigitExtraction

The DialedDigitExtraction message reports intercept subject-dialed digits when a call is connected to another TSP's service for processing and routing. The post-cut through digits are digits dialed or signaled by the intercept subject after the initial call setup is completed and the call path is cut-through in both directions at the IAP switch. The digits may be reported on a digit-by-digit basis, accumulated until a buffer is filled, accumulated until a timer expires, or accumulated until the call is released.

A TSP may report dialed digits other than those that are call completing and has no obligation to determine which dialed digits actually complete a call.

The DialedDigitExtraction message shall be triggered only for circuit-mode calls when:

- digit-by-digit reporting is performed and a digit is detected; or
- digit accumulation is performed and the first of the following occurs:
 - i. a maximum of 32 digits have been accumulated in the buffer;
 - ii. 20 seconds have elapsed since detection of the first digit in the buffer; or
 - iii. the call is released.

The DialedDigitExtraction message includes the following parameters:

Table 8: DialedDigitExtraction Message Parameters

Parameter	MOC	Usage
CaseIdentity	M	Identifies the Intercept Subject.
IAPSystemIdentity	C	Included to identify the system containing the IAP when the underlying data carriage does not imply that system.
TimeStamp	M	Identifies the date and time that the triggering event was detected.
CallIdentity	M	Uniquely identifies a call, call appearance, or call leg within a system.
Digits	M	Identifies the DTMF-tones transmitted by the intercept subject after the call is cut-through in both directions.

See 6.3.8 "DialedDigitExtraction Message" on page 68 for the Stage 3 description.

5.4.9 NetworkSignal

The NetworkSignal message reports signals generated or sent by the IAP switch to the intercept subject using the facilities under surveillance. The network signals reported by the NetworkSignal message are signals originated and applied by the accessing system IAP towards the intercept subject.

The NetworkSignal message is triggered when a network signal that provides call-identifying information is originated and applied by the IAP switch to an intercept subject.

The following triggering events are defined (referenced from LSSGR, ANSI-41 and GSM 02.40):

- a. Dial tone is applied indicating an intercept subject has gone off-hook and the IAP is ready to accept address information from the intercept subject.
- b. Recall dial tone is applied indicating that an IAP is ready to accept address information or other information from an intercept subject.
- c. Expensive route warning tone is applied indicating an intercept subject has accessed the Automatic Flexible Routing (AFR) feature and the IAP switch selected outgoing route is designated as an expensive route.
- d. Busy tone is applied indicating an intercept subject-originated incomplete call attempt.
- e. Reorder tone or Congestion tone is applied indicating an intercept subject-originated incomplete call attempt.
- f. Receiver Off-Hook (ROH) tone is applied indicating the intercept subject has left the phone receiver off hook and the line is receiving permanent signal treatment. This tone is also used in place of ringing when an operator system needs to alert an off-hook line.
- g. Special Information Tone (SIT) is applied indicating an intercept subject-originated call has been routed to an announcement. SIT tones precede IAP switch generated announcements to permit the user and network equipment to detect the type of recorded announcement that follows the tone.
- h. Ringback tone or Audible alerting is applied indicating an intercept subject-originated call attempt has progressed and the called party is being alerted.
- i. Barge-in tone is applied indicating someone is about to barge-in on the intercept subject's active call.
- j. Call-associated out-of-band signal that is normally perceivable (seen or heard) by the intercept subject, such as tone commands (i.e., tones off) or visual call status indicator.
- k. Alerting tone is applied indicating an incoming call attempt to the intercept subject.
- l. Distinctive alerting tone is applied to allow classification of incoming calls to the intercept subject based on the called number or based on the calling number.

PN-4465-RV1

- 1
2
3
4
5
6
7
8
9
10
11
12
13
14
15
16
17
18
19
20
21
22
23
24
25
26
27
28
29
30
31
32
33
34
35
36
37
38
39
40
41
42
43
44
45
46
47
48
49
50
51
52
53
54
55
56
57
58
59
- m. Reminder ring is applied to notify the intercept subject when a terminating call has been redirected.
 - n. Call waiting tone is applied indicating an incoming call to the intercept subject while the subject is in the communications state with another call.
 - o. Distinctive call waiting tone is applied to allow classification of incoming calls to the intercept subject, while the subject is in the communications state with another call, based on the called number or based on the calling number.
 - p. Confirmation tone is applied indicating the IAP has received information and has processed the request, such as the activation or deactivation of a feature or service.
 - q. Message waiting indicator tone is applied indicating message waiting services are available. This tone also indicates that the IAP is ready to accept address information or other information.
 - r. Denial tone (single 2.0 seconds burst of 480 Hz tone added to a 620 Hz tone) is applied towards the intercept subject indicating denial of a feature request.
 - s. Signaling information is delivered to the intercept subject identifying calling name and number and redirecting party name and number.
 - t. Alphanumeric information associated with a circuit-mode call is delivered to the intercept subject, such as text provided in the Q.931 display information element (e.g., calling name, redirecting name).
 - u. Intercept tone or Mobile Reorder tone (alternating 440Hz and 620 Hz tones each on for 250 ms.) is applied toward the intercept subject.
 - v. Answer tone is applied toward the intercept subject.
 - w. Tones off. All tones off.
 - x. Pip tone (four bursts (0.1 second on, 0.1 second off) of 480 Hz tone, and then off) is applied toward the intercept subject .
 - y. Abbreviated Intercept tone (4 seconds of Intercept tone) is applied toward the intercept subject.
 - z. Abbreviated Congestion tone (4 seconds of Congestion tone) is applied toward the intercept subject.
 - aa. Warning tone (a single 0.1 second burst of 480 Hz tone) is applied toward the intercept subject.
 - ab. Dial tone burst tone (a single 2.0 seconds burst of Dial tone) is applied toward the intercept subject.
 - ac. Standard announcement is applied toward the intercept subject as applicable per ANSI-41.
 - ad. Number Unobtainable tone is applied toward the intercept subject indicating that the dialed number is invalid or unobtainable.
 - ae. Authentication Failure tone is applied toward the intercept subject indicating that an authentication attempt has failed.

The NetworkSignal message includes the following parameters:

Table 9: NetworkSignal Message Parameters

Parameter	MOC	Usage
CaseIdentity	M	Identifies the Intercept Subject.
IAPSystemIdentity	C	Included to identify the system containing the IAP when the underlying data carriage does not imply that system.
TimeStamp	M	Identifies the date and time that the event was detected.
CallIdentity	C	Included when the network signal is associated with a particular call.
Signal	M	Identifies the audio signals, visual signals, or displayed text applied by the accessing system that would normally be sensed by the intercept subject.
One or more of the following:		
AlertingSignal		Included when alerting is applied to the intercept subject's terminal to indicate it's type.
SubjectAudibleSignal		Included when audible signal is applied toward the intercept subject.
TerminalDisplayInfo		Included when messages that may be displayed on the intercept subject's terminal are sent by the IAP including display messages, called number, calling party numbers, redirecting numbers, etc.
Other		Included as an alternative means of reporting the signaling information.

See 6.3.9 "NetworkSignal Message" on page 68 for the Stage 3 description.

PN-4465-RV1

1
2
3
4
5
6
7
8
9
10
11
12
13
14
15
16
17
18
19
20
21
22
23
24
25
26
27
28
29
30
31
32
33
34
35
36
37
38
39
40
41
42
43
44
45
46
47
48
49
50
51
52
53
54
55
56
57
58
59

5.4.10 Origination

The Origination message reports circuit-mode call origination attempts or number translations for the intercept subject. More than one Origination message is possible for a single call attempt when numbers are expanded or translated.

The Origination message shall be triggered when:

- a call or call leg originated by the intercept subject is routed toward a destination within the accessing system;
- a call or call leg originated by the intercept subject is routed toward a destination on an external public or private network;
- the destination number for a call or call leg originated by the intercept subject is translated from one set of digits to another. For example, speed number expansion or 800-number translation;
- a call was attempted that was partially dialed, or that could not be completed by the accessing system; or
- a feature code was dialed or otherwise transmitted.

The Origination message includes the following parameters:

Table 10: Origination Message Parameters

Parameter	MOC	Usage
CasIdentity	M	Identifies the Intercept Subject.
IAPSystemIdentity	C	Include to identify the system containing the IAP when the underlying data carriage does not imply that system.
TimeStamp	M	Identifies the date and time that the event was detected.
CallIdentity	M	Uniquely identifies a call, call appearance, or call leg within a system. A unique call identity may be generated for the Origination message which is used to correlate other messages. An exception is possible when such an attempt is considered part of an on-going call (e.g., three-way calling or conference calling for some systems).
Calling PartyIdentity	C	Include, when more specific than the intercept subject identity associated with the CasIdentity, to identify the originating party.
Called PartyIdentity	C	Include, when known to identify the called party. This shall not be present for calls that were partially dialed or could not be completed by the accessing system.
Input	M	Identifies specific user or translation input including when a call is attempted without input (e.g., hot line).
Location	C	Include, when the location information is reasonably available at the IAP and delivery is authorized, to identify the location of an intercept subject's mobile terminal.
TransitCarrierIdentity	C	Include, when the transit network selection is known, to identify the transit carrier.
BearerCapability	C	Include, when known (or presumed), to indicate the requested bearer service for the origination.

See 6.3.10 "Origination Message" on page 69 for the Stage 3 description.

5.4.11 PacketEnvelope

The PacketEnvelope message is used to convey data packets over the CDC as they are intercepted. (Packet-mode communications delivered over CCCs or packet-mode communications using circuit-mode facilities do not use the PacketEnvelope.)

The PacketEnvelope message shall be triggered for the appropriate types of packet data services when:

- a packet-mode user communication intended for the intercept subject is detected; or
- a packet-mode user communication from the intercept subject is detected.

The PacketEnvelope message includes the following parameters:

Table 11: PacketEnvelope Message Parameters

Parameter	MOC	Usage
CaselIdentity	M	Identifies the Intercept Subject.
IAPSystemIdentity	C	Included to identify the system containing the IAP when the underlying data carriage does not imply that system.
TimeStamp	M	Identifies the date and time that the event was detected.
CallIdentity	C	Include when the packet is associated with a particular call, call appearance, or call leg.
Location	C	Include, when the location information is reasonably available at the IAP and delivery is authorized, to identify the location of an intercept subject's mobile terminal.
Packet Information One of: ISDN- or ISUP-based user-to-user signaling information TIA/EIA-41-based short message service GSM-based short message service Wireless IP-based service	M	Information pertaining to ISDN or ISUP user-to-user signaling messages. Information pertaining to TIA/EIA-41 short message service messages. Information pertaining to GSM short message service messages. Information pertaining to wireless IP-based service messages (e.g., CDPD). This parameter may also be used to information pertaining to non-wireless IP-based services.

See 6.3.11 "PacketEnvelope Message" on page 70 for the Stage 3 description.

5.4.12 Redirection

The Redirection message reports the redirection of a circuit-mode call.

The Redirection message shall be triggered when:

- an incoming call attempt to the intercept subject is forwarded (e.g., call forwarding or call diversion);
- an incoming call attempt to the intercept subject is deflected (e.g., call waiting deluxe or call deflection); or
- an incoming call attempt to an intercept subject with terminal or personal mobility is redirected to the intercept subject's current location (e.g., call delivery).

The Redirection message includes the following parameters:

Table 12: Redirection Message Parameters

Parameter	MOC	Usage
CaselIdentity	M	Identifies the Intercept Subject.
IAPSystemIdentity	C	Included to identify the system containing the IAP when the underlying data carriage does not imply that system.
TimeStamp	M	Identifies the date and time that the event was detected.
CallIdentity	M	Uniquely identifies a call within a system.
Redirected-to PartyIdentity	M	Identifies the redirected-to party.
TransitCarrierIdentity	C	Included when the transit network selection is known to identify the transit carrier.
BearerCapability	C	Included when known (or presumed) to indicate the requested bearer service for the redirection.
System Identity	C	Included when a call to a wireless subscriber is redirected to another TSP and that identity is reasonably available.

See 6.3.12 "Redirection Message" on page 71 for the Stage 3 description.

5.4.13 Release

The Release message reports the release of the resources used for a circuit-mode call, call appearance, or call leg.

The Release message shall be triggered when:

- a circuit-mode call attempt is abandoned by the calling party; or
- a completed circuit-mode call is released.

The Release message may be triggered when a call leg or call appearance is released.

The Release message includes the following parameters:

Table 13: Release Message Parameters

Parameter	MOC	Usage
Caselidentity	M	Identifies the Intercept Subject.
IAPSystemIdentity	C	Included to identify the system containing the IAP when the underlying data carriage does not imply that system.
TimeStamp	M	Identifies the date and time that the event was detected.
CallIdentity	M	Uniquely identifies a call, call appearance, or call leg within a system. The call identity is released.
Location	C	Include, when the location information is reasonably available at the IAP and delivery is authorized, to identify the location of an intercept subject's mobile terminal.
System Identity	C	Include, when a handed-off wireless call is released while being served by another TSP, to identify the last known TSP serving the subject.

See 6.3.13 "Release Message" on page 71 for the Stage 3 description.

5.4.14 ServingSystem

The ServingSystem message reports the TSP providing service to an intercept subject with terminal mobility, when the terminal is authorized for service.

A ServingSystem report shall be triggered when a mobile terminal is authorized for service with another TSP or in another service area.

The ServingSystem message includes the following parameters:

Table 14: ServingSystem Message Parameters

Parameter	MOC	Usage
CaselIdentity	M	Identifies the Intercept Subject.
IAPSystemIdentity	C	Included to identify the system containing the IAP when the underlying data carriage does not imply that system.
TimeStamp	M	Identifies the date and time that the event was detected.
SystemIdentity	C	Include, when authorizing service to a TSP, to identify the TSP.
NetworkAddress	C	Include, when available, to identify the redirect-to number of the base station (e.g., a personal or residential base station) providing service to the intercept subject.

See 6.3.14 “ServingSystem Message” on page 72 for the Stage 3 description.

PN-4465-RV1

1
2
3
4
5
6
7
8
9
10
11
12
13
14
15
16
17
18
19
20
21
22
23
24
25
26
27
28
29
30
31
32
33
34
35
36
37
38
39
40
41
42
43
44
45
46
47
48
49
50
51
52
53
54
55
56
57
58
59

5.4.15 SubjectSignal

The SubjectSignal message reports subject-initiated signals used to control a feature or service operation (e.g., call forwarding, call waiting, call hold and three-way calling). The user input may be uninterpretable and would result in no change in the control of a call, but a SubjectSignal message may still be generated.

The signal may be in-band or out-of-band and may be call-associated or non call-associated. However, digits dialed post cut-through as defined in [section 5.4.8 “DialedDigitExtraction”](#) are not detected by this function and are thus not provided in a SubjectSignal message.

The SubjectSignal message shall be triggered when:

- the intercept subject, using the facilities under surveillance, dials or signals to control services provided by the serving system;
- sufficient input has been received (e.g., the receiving IAP network element acts on the subject-initiated input); or
- the call attempt is abandoned with partial input (e.g., the interdigit timer expires or a subject abandons the call).

This message is not required when the information reported would be redundant with the information reported by other LAES call event messages.

The SubjectSignal message includes the following parameters:

Table 15: SubjectSignal Message Parameters

Parameter	MOC	Usage
CaseIdentity	M	Identifies the Intercept Subject.
IAPSystemIdentity	C	Included to identify the system containing the IAP when the underlying data carriage does not imply that system.
TimeStamp	M	Identifies the date and time that the event was detected.
CallIdentity	C	Included when known to uniquely identify a call, call appearance, or call leg within a system.
Signal	M	Identifies the signal or dialing the IAP detects as originating from the intercept subject. Include to report specific subject-initiated input when detected at the IAP.
One or more of the following: SwitchhookFlash DialedDigits FeatureKey OtherSignalingInformation		Included when the user requests a switchhook flash. Included when digits are dialed. Included when a particular feature key was pressed. Included when other signaling information is initiated by the intercept subject.

See 6.3.15 “SubjectSignal Message” on page 72 for the Stage 3 description.

5.4.16 TerminationAttempt

The TerminationAttempt message reports an incoming circuit-mode call attempt to the intercept subject. This message shall be sent regardless of the disposition of the call (e.g., busy, answered, redirected).

The TerminationAttempt message shall be triggered when:

- an incoming call to an intercept subject is detected; or
- a recall attempt involving the intercept subject is detected (e.g., hold recall, transfer recall, or attendant recall).

The TerminationAttempt message includes the following parameters:

Table 16: TerminationAttempt Message Parameters

Parameter	MOC	Usage
CasIdentity	M	Identifies the Intercept Subject.
IAPSystemIdentity	C	Included to identify the system containing the IAP when the underlying data carriage does not imply that system.
TimeStamp	M	Identifies the date and time that the event was detected.
CallIdentity	M	Uniquely identifies a call, call appearance, or call leg within a system. A unique call identity is generated for the TerminationAttempt message which is used to correlate other messages. An exception is possible when such an attempt is considered part of an on-going call (e.g., call waiting for some systems).
Calling PartyIdentity	M	Identifies the calling party to the extent known.
Called PartyIdentity	C	Include, when more specific than the subject identity associated with the CasIdentity, to identify the called party.
BearerCapability	C	Include, when known (or presumed), to identify the requested bearer service.
RedirectedFromInformation	C	Include when the incoming call has information about previous redirection.

See 6.3.16 “TerminationAttempt Message” on page 73 for the Stage 3 description.

1
2
3
4
5
6
7
8
9
10
11
12
13
14
15
16
17
18
19
20
21
22
23
24
25
26
27
28
29
30
31
32
33
34
35
36
37
38
39
40
41
42
43
44
45
46
47
48
49
50
51
52
53
54
55
56
57
58
59

(This page intentionally left blank.)

PN-4465-RV1

6 Stage 3 Description: Implementation Perspective

6.1 Protocol Definition

A protocol is defined in three basic aspects:

- a. Transfer Syntax,
- b. Transfer Semantics, and
- c. Procedures.

The transfer syntax defines the messages passed between two functional entities. This definition may include various structures, but eventually defines the entire message structure down to the bit level. The syntax specifies the ways in which bits of messages are encoded for exchanging information between two functional entities.

The transfer semantics assigns meanings to the bits, bytes and structures of the transfer syntax. The exchanges of meanings allows the functional entities to share information and to act upon that information.

Procedures define the behavior of the functional entities. Procedures define which functional entities are allowed to initiate a particular transaction. Procedures define the possible responses to a given stimulus especially when dependent upon prior exchanges.

6.2 CDC Protocol Definition

6.2.1 CDC Underlying Data Transmission

The CDC messages defined by this Interim Standard are an Open System Interconnection (OSI) Layer 7 or Application Layer protocol. The protocol for the CDC messages is called the Lawfully Authorized Electronic Surveillance Protocol (LAESP). The LAESP messages shall be delivered over CDCs employing a Interim Standard or widely used data communication protocol.

6.2.2 CDC Parameter Encoding Objectives

The following are the objectives of the parameter encoding:

- a. Allow flexible usage of the LAESP to transport a variety of information.
- b. Provide a consistent and complete syntax for transferring information.
- c. Facilitate implementation of message encoding and decoding software by using standardized techniques.
- d. Allow as much syntactical checking as practical to be performed by the message parsers rather than deferring to the application.
- e. Allow for parameter extension and modification throughout the life of the protocol.

6.2.3 CDC Syntax Definitions

The transferred information and messages shall be encoded to be binary compatible with *X.208 Abstract Syntax Notation One* (ASN.1) and the *X.209 Basic Encoding Rules* (BER).

These recommendations use precise definitions of the words *type*, *class*, *value*, and *parameter*. Those definitions are paraphrased below for clarity.

A *type*; in the context of the abstract syntax or transfer syntax, is a set of all possible values. For example, an INTEGER is a type for all negative and positive integers.

A *class*, in the context of the abstract syntax or transfer syntax, is a one of four possible domains for uniquely defining a type. The classes defined by ASN.1 and BER are: UNIVERSAL, APPLICATION, CONTEXT, and PRIVATE. The UNIVERSAL class is reserved for international standards such as *X.208* and *X.209*. Most parameter type identifiers in the LAESP are encoded as CONTEXT specific class. Users of the LAESP may extend the protocol with PRIVATE class parameters without conflict with this Interim Standard, but risk conflict with other users' extensions. APPLICATION class parameters are reserved by the LAESP Interim Standard for future extensions.

A *value* is a particular instance of a type. For example, five (5) is a possible value of the type INTEGER.

A *parameter* in this Interim Standard is a particular instance of the transfer syntax to transport a value consisting of a tag to identify the parameter type, a length to specify the number of octets in the value, and the value.

In the BER a *tag* (a particular type and class identifier) may either be a primitive or a constructor. A *primitive* is a pre-defined type (of class UNIVERSAL) and a *constructor* consists of other types (primitives or other constructors). A constructor type may either be *IMPLICIT* or *EXPLICIT*. An *IMPLICIT* type is encoded with the constructor identifier alone. Both ends of a communication must understand the underlying structure of the *IMPLICIT* types. *EXPLICIT* types are encoded with the identifiers of all the contained types. For example, an *IMPLICIT* Number of type INTEGER would be tagged only with the "Number" tag, where an *EXPLICIT* Number of type INTEGER would have the "INTEGER" tag within the "Number" tag. This Interim Standard uses *IMPLICIT* tagging for more compact message encoding. Parameters of the CHOICE type are encoded *EXPLICIT* to ensure compatibility with various ASN.1 versions and compilers.

PN-4465-RV1

6.3 CDC Message Definitions

The LAESMessage parameter defines the LAES messages.

```

Laesp DEFINITIONS IMPLICIT TAGS ::=
BEGIN

LAESMessage ::= CHOICE {
    answer          [1] Answer,
    ccClose         [2] CCClose,
    ccOpen          [3] CCOpen,
    change          [4] Change,
    origination     [5] Origination,
    packetEnvelope [6] PacketEnvelope,
    redirection     [7] Redirection,
    release         [8] Release,
    servingSystem  [9] ServingSystem,
    termAttempt    [10] TerminationAttempt,
    -- connTest    [11] ConnectionTest, - - see Annex F
    confPartyChange [12] ConferencePartyChange,
    connection     [13] Connection,
    connectBreak   [14] ConnectionBreak,
    dialedDgtExtrn [15] DialedDigitExtraction,
    networkSignal  [16] NetworkSignal,
    subjectSignal  [17] SubjectSignal
}

```

6.3.1 Answer Message

The Answer message is used to report that a connection-oriented call or leg has been answered.

```

Answer ::= SEQUENCE {
    [0] CaseIdentity,
    [1] IAPSystemIdentity OPTIONAL,
    -- include to identify the system containing the Intercept Access
    -- Function when the underlying data carriage does not imply that system.
    [2] TimeStamp,
    [3] CallIdentity,
    answering [4] PartyIdentity OPTIONAL,
    -- include, when known, to identify the answering party or agent
    [5] Location OPTIONAL,
    -- Include, when a terminating call is answered, the location
    -- information is reasonably available to the IAP and delivery is
    -- authorized, to identify the location of an intercept subject's
    -- mobile terminal
    [6] EXPLICIT BearerCapability OPTIONAL
    -- include, when known (or presumed), to indicate the granted bearer
    -- capability.
}

```

See 5.4.1 “Answer” on page 40 for the Stage 2 description.

PN-4465-RV1

6.3.2 CCClose Message

The CCClose message is used to report the end of call content delivery on the CCC.

```

6 CCClose ::= SEQUENCE {
7     [0] CaseIdentity,
8     [1] IAPSystemIdentity          OPTIONAL,
9     -- include to identify the system containing the Intercept Access
10    -- Function when the underlying data carriage does not imply that system.
11    [2] TimeStamp,
12    [3] EXPLICIT CCCIdentity
13 }

```

See 5.4.2 “CCClose” on page 41 for the Stage 2 description.

6.3.3 CCOpen Message

The CCOpen message is used to report the beginning of call content delivery on the CCC.

```

22 CCOpen ::= SEQUENCE {
23     [0] CaseIdentity,
24     [1] IAPSystemIdentity          OPTIONAL,
25     -- include to identify the system containing the Intercept Access
26     -- Function when the underlying data carriage does not imply that system.
27     [2] TimeStamp,
28     CHOICE {
29         [3] SEQUENCE OF CallIdentity, -- for circuit-mode intercepts
30         [4] PDUType                -- for packet-mode intercepts
31     },
32     [5] EXPLICIT CCCIdentity
33 }

```

See 5.4.3 “CCOpen” on page 42 for the Stage 2 description.

6.3.4 Change Message

The Change message is used to report merging or splitting of connection-oriented call identities.

```

41 Change ::= SEQUENCE {
42     [0] CaseIdentity,
43     [1] IAPSystemIdentity          OPTIONAL,
44     -- include to identify the system containing the Intercept Access
45     -- Function when the underlying data carriage does not imply that system.
46     [2] TimeStamp,
47     previous [3] SEQUENCE OF -- previous call(s)
48             SEQUENCE OF CallIdentity, -- identity(ies) of a previous call
49     resulting [4] SEQUENCE OF SEQUENCE { -- resulting call(s)
50         [0] SEQUENCE OF CallIdentity, -- identity(ies) of resulting call
51         [1] EXPLICIT CCCIdentity     OPTIONAL
52         -- included when the content of the resulting call is delivered
53         -- to identify the CCC(s).
54     }
55 }

```

See 5.4.4 “Change” on page 44 for the Stage 2 description.

6.3.5 ConferencePartyChange Message

The ConferencePartyChange message reports a change in the parties to a subject initiated conference call communication.

```

ConferencePartyChange ::= SEQUENCE {
    [0] CaseIdentity,
    [1] IAPSystemIdentity OPTIONAL,
    -- include to identify the system containing the Intercept Access
    -- Function when the underlying data carriage does not imply that system.
    [2] TimeStamp,
    communicating
    [3] SEQUENCE OF SEQUENCE{
        -- include to identify parties participating in the communication.
        [0] SEQUENCE OF CallIdentity OPTIONAL,
        -- identifies communicating call identities.
        [1] SEQUENCE OF PartyIdentity OPTIONAL,
        -- identifies communicating party identities.
        [2] EXPLICIT CCCIdentity OPTIONAL
        -- included when the content of the resulting call is delivered
        -- to identify the associated CCC(s).
    } OPTIONAL,
    dropped
    [4] SEQUENCE OF SEQUENCE{
        -- include to identify parties dropped from the communication.
        [0] SEQUENCE OF CallIdentity OPTIONAL,
        -- identifies previously communicating, now dropped call
        -- identity(ies).
        [1] SEQUENCE OF PartyIdentity OPTIONAL,
        -- identifies previously communicating, now dropped party
        -- identity(ies).
        [2] EXPLICIT CCCIdentity OPTIONAL
        -- included when a party(ies) to an existing communication
        -- is dropped, to identify the associated CCC(s).
    } OPTIONAL,
    removed
    [5] SEQUENCE OF SEQUENCE{
        -- include to identify parties removed (e.g., hold service) from the
        -- communication.
        [0] SEQUENCE OF CallIdentity OPTIONAL,
        -- identifies removed call identity(ies).
        [1] SEQUENCE OF PartyIdentity OPTIONAL,
        -- identifies removed party identity(ies).
        [2] EXPLICIT CCCIdentity OPTIONAL
        -- included when a party(ies) to an existing communication
        -- is removed, to identify the CCC(s).
    } OPTIONAL,
    joined
    [6] SEQUENCE OF SEQUENCE{
        -- include to identify parties newly added to the communication.
        [0] SEQUENCE OF CallIdentity OPTIONAL,
        -- identifies newly added call identity(ies) to an existing
        -- communication.
        [1] SEQUENCE OF PartyIdentity OPTIONAL,
        -- identifies newly added party identity(ies) to an existing
        -- communication.
        [2] EXPLICIT CCCIdentity OPTIONAL
        -- included when a party to an existing communication
        -- is added, to identify the associated CCC(s).
    } OPTIONAL
}

```

See 5.4.5 “ConferencePartyChange” on page 45 for the Stage 2 description.

6.3.6 Connection Message

The Connection message reports parties to a call under surveillance.

```

1
2
3
4
5
6 Connection ::= SEQUENCE {
7   [0] CaseIdentity,
8   [1] IAPSystemIdentity OPTIONAL,
9   -- include to identify the system containing the Intercept Access
10  -- Function when the underlying data carriage does not imply that system.
11  [2] TimeStamp,
12  [3] SEQUENCE OF CallIdentity,
13  -- Connection Information
14  -- The following two parameters are considered Connection Information.
15  -- Include at least one of the following.
16
17  connectedParties [4] SEQUENCE OF PartyIdentity
18  OPTIONAL,
19  newParties [5] SEQUENCE OF PartyIdentity
20  OPTIONAL
21 }

```

See 5.4.6 “Connection” on page 47 for the Stage 2 description.

6.3.7 ConnectionBreak Message

The ConnectionBreak message reports parties removed from a call under surveillance.

```

26
27
28
29
30 ConnectionBreak ::= SEQUENCE {
31   [0] CaseIdentity,
32   [1] IAPSystemIdentity OPTIONAL,
33   -- include to identify the system containing the Intercept Access
34   -- Function when the underlying data carriage does not imply that system.
35   [2] TimeStamp,
36   [3] SEQUENCE OF CallIdentity,
37   -- ConnectionBreak Information
38   -- The following three parameters are considered ConnectionBreak
39   -- Information. Include at least one of the following.
40   removedParties [4] SEQUENCE OF PartyIdentity
41   OPTIONAL,
42   remainingParties [5] SEQUENCE OF PartyIdentity
43   OPTIONAL,
44   droppedParties [6] SEQUENCE OF PartyIdentity
45   OPTIONAL
46 }

```

See 5.4.7 “ConnectionBreak” on page 48 for the Stage 2 description.

6.3.8 DialedDigitExtraction Message

The DialedDigitExtraction message reports post cut-through digits dialed by the intercept subject.

```

DialedDigitExtraction ::= SEQUENCE {
    [0] CaseIdentity,
    [1] IAPSystemIdentity OPTIONAL,
    -- include to identify the system containing the Intercept Access
    -- Function when the underlying data carriage does not imply that system.
    [2] TimeStamp,
    [3] CallIdentity,
    digits [4] VisibleString (SIZE (1..32))
    -- e.g., "12345" or "*123" or "#345"
}
    
```

See 5.4.8 “DialedDigitExtraction” on page 49 for the Stage 2 description.

6.3.9 NetworkSignal Message

The NetworkSignal message reports network signals sent to the intercept subject.

```

NetworkSignal ::= SEQUENCE {
    [0] CaseIdentity,
    [1] IAPSystemIdentity OPTIONAL,
    -- include to identify the system containing the Intercept Access
    -- Function when the underlying data carriage does not imply that system.
    [2] TimeStamp,
    [3] CallIdentity OPTIONAL,
    -- Signal
    -- The following four parameters are considered network-generated
    -- signals. Include at least one of the following four parameters to
    -- identify the signal being applied by the IAP.
    alertingSignal [4] AlertingSignal OPTIONAL,
    subjectAudibleSignal [5] AudibleSignal OPTIONAL,
    terminalDisplayInfo [6] TerminalDisplayInfo OPTIONAL,
    other [7] VisibleString (SIZE (1..128)) OPTIONAL
    -- e.g., standard announcement or name of an announcement as per
    -- ANSI-41.
}
    
```

See 5.4.9 “NetworkSignal” on page 50 for the Stage 2 description.

PN-4465-RV1

1
2
3
4
5
6
7
8
9
10
11
12
13
14
15
16
17
18
19
20
21
22
23
24
25
26
27
28
29
30
31
32
33
34
35
36
37
38
39
40
41
42
43
44
45
46
47
48
49
50
51
52
53
54
55
56
57
58
59

6.3.10 Origination Message

The Origination message reports authorized connection-oriented call origination attempts or number translations for the intercept subject performed by the Access Function.

```

7  Origination ::= SEQUENCE {
8      [0] CaseIdentity,
9      [1] IAPSystemIdentity          OPTIONAL,
10     -- include to identify the system containing the Intercept Access
11     -- Function when the underlying data carriage does not imply that system.
12     [2] TimeStamp,
13     [3] CallIdentity,
14     calling [4] PartyIdentity          OPTIONAL,
15     -- include, when more specific than the subject identity associated
16     -- with the CaseIdentity, to identify the calling number
17     called [5] PartyIdentity          OPTIONAL,
18     -- include if known
19     input CHOICE {
20     userInput [6] VisibleString (SIZE (1..32)),
21     -- use if input is known to be from the user
22     -- e.g., "" (hot line), "12025551234" or "*123"
23     translationInput [7] VisibleString (SIZE (1..32))
24     -- use for inputs to translation
25     -- e.g., "" (hot line), "12025551234" or "*123"
26     },
27     [8] Location          OPTIONAL,
28     -- Include, when the location information is reasonably available to
29     -- the IAP and delivery is authorized, to identify the location of an
30     -- intercept subject's mobile terminal
31     [9] TransitCarrierIdentity          OPTIONAL,
32     -- include if known
33     [10] EXPLICIT BearerCapability          OPTIONAL
34     -- include if known (or presumed)
35 }

```

See 5.4.10 "Origination" on page 53 for the Stage 2 description.

6.3.11 PacketEnvelope Message

The PacketEnvelope message delivers intercepted packets to an LEA.

```

PacketEnvelope ::= SEQUENCE {
    [0] CaseIdentity,
    [1] IAPSystemIdentity          OPTIONAL,
    -- include to identify the system containing the Intercept Access
    -- Function when the underlying data carriage does not imply
    -- that system.
    [2] TimeStamp,
    [3] CallIdentity              OPTIONAL,
    [4] Location                  OPTIONAL,
    -- Include, when the location information is reasonably available
    -- to the IAP and delivery is authorized, to identify the
    -- location of an intercept subject's mobile terminal
    packetInformation             CHOICE {
        isdnUserToUserSignaling  [5] SEQUENCE {
            callIdentity          [0] CallIdentity,
            sending                [1] PartyIdentity,
            interceptedUUPacket    [2] OCTET STRING (SIZE (1..128))    OPTIONAL
            -- Encoded according to T1.607 User-to-user
            -- information element starting with Octet 4.
        },
        tiaEia41ShortMessageService [6] SEQUENCE {
            originalOriginatingAddress [0] PartyIdentity,
            originalDestinationAddress [1] PartyIdentity,
            originatingAddress         [2] PartyIdentity          OPTIONAL,
            -- include if known and different than the
            -- originalOriginatingAddress
            destinationAddress         [3] PartyIdentity          OPTIONAL,
            -- include if known and different than the
            -- originaldestinationAddress
            smsTeleserviceIdentifier   [4] INTEGER (-32768..32767), --see TIA/EIA-41
            interceptedISSMSPacket     [5] OCTET STRING (SIZE (1..255))    OPTIONAL
        },
        gsmSMSShortMessageService    [7] SEQUENCE {
            senderAddress             [0] PartyIdentity,
            receiverAddress           [1] PartyIdentity,
            interceptedGSMSPacket     [2] OCTET STRING (SIZE (1..255))    OPTIONAL
        },
        wirelessIPService            [8] SEQUENCE {
            -- This parameter may also be used for
            -- information pertaining to non-wireless
            -- IP-based services.
            originatingAddress        [0] PartyIdentity,
            destinationAddress        [1] PartyIdentity,
            interceptedIPPacket        [2] OCTET STRING (SIZE (1..70000))    OPTIONAL
        }
    }
}

```

See 5.4.11 "PacketEnvelope" on page 55 for the Stage 2 description.

PN-4465-RV1

6.3.12 Redirection Message

The Redirection message indicates that an incoming connection-oriented call attempt, originally directed toward a subject, has been redirected by the subject.

```

7 Redirection ::= SEQUENCE {
8     [0] CaseIdentity,
9     [1] IAPSystemIdentity          OPTIONAL,
10    -- include to identify the system containing the Intercept Access
11    -- Function when the underlying data carriage does not imply that system.
12    [2] TimeStamp,
13    [3] CallIdentity,
14    redirectedTo [4] PartyIdentity,
15    [5] TransitCarrierIdentity     OPTIONAL,
16    -- include if known
17    [6] EXPLICIT BearerCapability  OPTIONAL,
18    -- include if known (or presumed)
19    systemIdentity [7] VisibleString (SIZE (1..15))  OPTIONAL
20    -- include when a call to a wireless subscriber is redirected to another
21    -- TSP and that identity is reasonably available.
22    -- e.g., "MSCID-12345-123" or "2025551234"
23    }

```

See 5.4.12 "Redirection" on page 56 for the Stage 2 description.

6.3.13 Release Message

The Release message is used to report that a connection-oriented call has been released.

```

30 Release ::= SEQUENCE {
31     [0] CaseIdentity,
32     [1] IAPSystemIdentity          OPTIONAL,
33     -- include to identify the system containing the Intercept Access
34     -- Function when the underlying data carriage does not imply that system.
35     [2] TimeStamp,
36     [3] CallIdentity,
37     [4] Location                   OPTIONAL,
38     -- Include, when the location information is reasonably available to
39     -- the IAP and delivery is authorized, to identify the location of an
40     -- intercept subject's mobile terminal
41     systemIdentity [5] VisibleString (SIZE (1..15))  OPTIONAL
42     -- include, when a handed-off wireless call is released while being
43     -- served by another TSP to identify the last known TSP serving the
44     -- subject, e.g., "MSCID-12345-123" or "2025551234"
45     }

```

See 5.4.13 "Release" on page 57 for the Stage 2 description.

PN-4465-RV1

6.3.14 ServingSystem Message

The ServingSystem message is used to report a change in the current TSP or service area for terminal or personal mobility.

```

ServingSystem ::= SEQUENCE {
    [0] CaseIdentity,
    [1] IAPSystemIdentity          OPTIONAL,
    -- include to identify the system containing the Intercept Access
    -- Function when the underlying data carriage does not imply that system.
    [2] TimeStamp,
systemIdentity [3] VisibleString (SIZE (1..15))          OPTIONAL,
    -- include, when authorizing service to a TSP, to identify the TSP
    -- e.g., "MSCID-12345-123" or "2025551234"
networkAddress [4] VisibleString (SIZE (1..15))          OPTIONAL
    -- include if the serving TSP can only be identified by
    -- a redirect-to number e.g., a personal or residential base station
    -- directory number "2025551234"
}

```

See 5.4.14 "ServingSystem" on page 58 for the Stage 2 description.

6.3.15 SubjectSignal Message

The SubjectSignal message reports all signaling input by the intercept subject.

```

SubjectSignal ::= SEQUENCE {
    [0] CaseIdentity,
    [1] IAPSystemIdentity          OPTIONAL,
    -- include to identify the system containing the Intercept Access
    -- Function when the underlying data carriage does not imply that system.
    [2] TimeStamp,
    [3] CallIdentity              OPTIONAL,
signal [4] SEQUENCE {
    -- signal
    -- The following four parameters are considered subject-initiated
    -- signaling information. Include at least one of the following four
    -- parameters to identify the subject-signaling information being
    -- reported.
switchhookFlash [0] VisibleString (SIZE (1..128))
    OPTIONAL,
    -- e.g., "FLASH"
dialDigits [1] VisibleString (SIZE (1..128))
    OPTIONAL,
    -- e.g. "12013452367", "*123",
featureKey [2] VisibleString (SIZE (1..128))
    OPTIONAL,
    -- e.g. "KEY1", "HOLD", "CONFERENCE" or any other
    -- function key.
otherSignalingInformation [3] VisibleString (SIZE (1..128))
    OPTIONAL
    -- e.g., "HOME"
}
}

```

See 5.4.15 "SubjectSignal" on page 59 for the Stage 2 description.

6.3.16 TerminationAttempt Message

The TerminationAttempt message is used to report a connection-oriented call termination attempt.

```

6 TerminationAttempt ::= SEQUENCE {
7     [0] CaseIdentity,
8     [1] IAPSystemIdentity           OPTIONAL,
9     -- include to identify the system containing the Intercept Access
10    -- Function when the underlying data carriage does not imply that system.
11    [2] TimeStamp,
12    [3] CallIdentity,
13    calling
14    called [4] PartyIdentity,
15    [5] PartyIdentity           OPTIONAL,
16    -- include, when more specific than the subject identity associated
17    -- with the CaseIdentity, to identify the called party.
18    [6] EXPLICIT BearerCapability  OPTIONAL,
19    -- included when known (or presumed)
20    [7] RedirectedFromInformation  OPTIONAL
21    -- include if this termination attempt is a result of a redirected call
22 }

```

See 5.4.16 “TerminationAttempt” on page 60 for the Stage 2 description.

6.4 CDC Parameter Definitions

6.4.1 AlertingSignal

The AlertingSignal parameter defines the pitch and cadence of the alerting (ringing) signal. The AlertingSignal parameter shall be encoded as follows:

```
AlertingSignal ::= ENUMERATED {
    notUsed                (0),
    alertingPattern0       (1), -- normal alerting
    alertingPattern1       (2), -- distinctive alerting - Intergroup
    alertingPattern2       (3), -- distinctive alerting: Special/Priority
    alertingPattern3       (4), -- Electronic Key Telephone Service
    alertingPattern4       (5), -- reminder ring
    callWaitingPattern1    (6), -- basic call waiting tone
    callWaitingPattern2    (7), -- incoming additional call tone
    callWaitingPattern3    (8), -- priority additional call tone
    callWaitingPattern4    (9), -- distinctive call waiting tone
    bargeInTone           (10)
}
```

See “NetworkSignal Message” on page 68.

6.4.2 AudibleSignal

The AudibleSignal parameter is used to report the type of audible tone that is generated by the IAP switch and applied to the intercept subject. The AudibleSignal parameter shall be encoded as follows:

```
AudibleSignal ::= ENUMERATED {
    notUsed                (0),
    dialTone               (1),
    recallDialTone         (2),
    ringbackTone           (3), -- RingbackTone or AudibleAlerting
    reorderTone            (4), -- ReorderTone or CongestionTone
    busyTone               (5),
    confirmationTone       (6),
    expensiveRouteTone     (7),
    messageWaitingTone     (8),
    receiverOffHookTone    (9),
    specialInfoTone        (10),
    denialTone             (11),
    interceptTone          (12), --InterceptTone or MobileReorder
    answerTone             (13),
    tonesOff               (14),
    pipTone                (15),
    abbreviatedIntercept   (16),
    abbreviatedCongestion  (17),
    warningTone            (18),
    dialToneBurst          (19),
    numberUnObtainableTone (20),
    authenticationFailTone (21)
}
```

See “NetworkSignal Message” on page 68.

6.4.3 BearerCapability

The BearerCapability parameter indicates a requested or granted bearer service.

```

6 BearerCapability ::= CHOICE {
7   speech                [0] NULL,
8   f3100HzAudio         [1] NULL,
9   bearerCapInfoElement [2] OCTET STRING (SIZE (1..64))
10      -- encoded according to T1.607 Bearer Capability information
11      -- element starting with octet 3
12 }

```

6.4.4 CallIdentity

The CallIdentity parameter is used to uniquely identify a particular call, call appearance, or call legs within the context of a single system. The CCOpen and Change messages can correlate the CallIdentity to one or more CCCs when content is delivered. A CallIdentity may be created with a CCOpen, Origination, TerminationAttempt, NetworkSignal or Change message. A CallIdentity may be released for other uses with a Release or Change message. CallIdentity shall not be immediately re-used. HLRs and similar systems that do not correlate messages with CallIdentity(ies) do not need to release the CallIdentity.

```

26 CallIdentity ::= SEQUENCE {
27   sequenceNumber      [0] VisibleString (SIZE (1..25)),
28   systemIdentity      [1] VisibleString (SIZE (1..15))      OPTIONAL
29      -- include when the system issuing the sequenceNumber is
30      -- different than the accessing system.
31      -- e.g., CLLI code, "MSCID-12345-123" or "2025551234" (E.164
32      -- address of node)
33 }

```

6.4.5 CaseIdentity

The CaseIdentity parameter contains a case identity assigned by the LEA for a particular electronic surveillance. The CaseIdentity will be designated by the LEA and provided to a TSP at the time of provisioning of an electronic surveillance.

```

42 CaseIdentity ::= VisibleString (SIZE (1..25))
43      -- e.g., "FBI-12345" or "NYPD-12345"

```

6.4.6 CCCIdentity

The CCCIdentity parameter identifies the CCC or pair of CCCs used for conveying call content. Each CCC is identified with a VisibleString which may contain a directory number (e.g., "202-555-1111"), a trunk identity (e.g., "FBITG-001" or "LAES-999"), an IP network address (e.g., "IP: 101.012.103.104:100") or an X.25 network address (e.g., "X121: 1234-5678901234").

```

CCCIdentity ::= CHOICE {
  combCCC      [0] VisibleString (SIZE (1..20)),      -- combined CCC
  sepCCCpair   [1] SEQUENCE {                        -- separated CCC
    sepXmitCCC [0] VisibleString (SIZE (1..20)), -- transmit path
    -- (from the intercept subject or redirected-to party)
    sepRecvCCC [1] VisibleString (SIZE (1..20)) -- receive path
    -- (to the intercept subject or redirected-to party)
  },
  indXmitCCC   [2] VisibleString (SIZE (1..20)), -- individual transmit path
  -- (from the intercept subject or redirected-to party)
  indRecvCCC   [3] VisibleString (SIZE (1..20)), -- individual receive path
  -- (to the intercept subject or redirected-to party)
  indCCC       [4] VisibleString (SIZE (1..20)) -- individual CCC without
  -- a specified direction. Use only in CCCclose messages.
}

```

6.4.7 IAPSystemIdentity

The IAPSystemIdentity parameter identifies the system of the Intercept Access Point and should not imply the specific location of an intercept subject.

```

IAPSystemIdentity ::= VisibleString (SIZE (1..15))
  -- e.g., CLLI code, "MSCID-12345-123" or "2025551234" (E.164 address of node)

```

6.4.8 Location

The Location parameter identifies the cell of the subject's mobile terminal.

```

Location ::= VisibleString (SIZE (1..32))      -- e.g., "WESTGATE" or "CELL017"

```

PN-4465-RV1

6.4.9 PartyIdentity

The PartyIdentity parameter identifies a party to a call or call attempt.

```

1 PartyIdentity ::= SEQUENCE {
2
3
4
5     -- include those identification elements necessary to uniquely
6     -- identify the party known at the point in call and are
7     -- authorized. At least one of the following parameters is
8     -- required.
9
10    esn                [0] VisibleString (SIZE (8))                OPTIONAL,
11                       -- AMPS-based Electronic Serial Number
12                       -- a hexadecimal string e.g., "82ABCDEF"
13    imei               [1] VisibleString (SIZE (1..15))            OPTIONAL,
14                       -- GSM-based International Mobile Equipment Identity
15    tei                [2] VisibleString (SIZE (1..15))            OPTIONAL,
16                       -- ISDN-based Terminal Equipment Identity
17    spid              [3] VisibleString (SIZE (3..20))              OPTIONAL,
18                       -- ISDN-based Service Profile Identifier
19    imsi              [4] VisibleString (SIZE (1..15))            OPTIONAL,
20                       -- International Mobile Station Identity
21                       -- E.212 number beginning with Mobile Country Code
22    min               [5] VisibleString (SIZE (10))                OPTIONAL,
23                       -- AMPS-based Mobile Identification Number
24    dn                [6] VisibleString (SIZE (1..15))            OPTIONAL,
25                       -- e.g., called directory number or network provided calling
26                       -- number.
27    userProvided      [7] VisibleString (SIZE (1..15))            OPTIONAL,
28                       -- user provided calling number as supplied
29    appearanceId      [8] VisibleString (SIZE (1..15))            OPTIONAL,
30                       -- include for instruments or services with multiple line,
31                       -- station, or call appearances
32    callingCardNum    [9] VisibleString (SIZE (1..20))            OPTIONAL,
33    ipAddress         [10] VisibleString (SIZE (1..32))            OPTIONAL,
34                       -- IPv4 addressing with decimal quad notation e.g.,
35                       -- "123.123.123.123" (not a URL)
36    x121              [11] VisibleString (SIZE (1..15))            OPTIONAL,
37                       -- begin with DNIC
38    trunkId           [12] VisibleString (SIZE (1..32))            OPTIONAL,
39                       -- indicate trunk group, trunk number or both
40                       -- This is usually used to identify an associate when other
41                       -- identifying information is not available.
42                       -- This may also identify a subject's agent (e.g., screening
43                       -- service).
44    subaddress        [13] OCTET STRING (SIZE (2..21))             OPTIONAL,
45                       -- encoded according to T1.607 Subaddress information element
46                       -- starting with octet 3.
47    genericAddress    [14] SEQUENCE OF VisibleString (SIZE (1..32)) OPTIONAL,
48                       -- indicate use of the generic address
49    genericDigits     [15] SEQUENCE OF VisibleString (SIZE (1..32)) OPTIONAL,
50                       -- indicate use of the generic digits
51    genericName       [16] SEQUENCE OF VisibleString (SIZE (1..48)) OPTIONAL,
52                       -- indicate use of the generic name
53    port              [17] VisibleString (SIZE (1..32))            OPTIONAL,
54                       -- identify a particular equipment port.
55                       -- This is used to identify an associate when other
56                       -- identifying information is not available.
57    context           [18] VisibleString (SIZE (1..64))            OPTIONAL,
58                       -- when none of the other identities are known or to
59                       -- identify the context and special considerations of the
60                       -- supplied identifier(s), especially when the identifier(s)
61                       -- is(are) abnormal (e.g., international, private, restricted,
62                       -- operator, no address, hotel/motel, coin, etc.)

```

PN-4465-RV1

```

isdnHighLayer      [19] OCTET STRING (SIZE (2..14))          OPTIONAL,
-- include if known
-- encoded according to T1.607 High Layer Compatibility
-- information element starting with octet 3
isdnLowLayer       [20] OCTET STRING (SIZE (2..14))          OPTIONAL
-- include if known
-- encoded according to T1.607 Low Layer Compatibility
-- information element starting with octet 3
}

```

6.4.10 PDUType

The PDUType parameter indicates the intercepted packet type on a CCC (e.g., see [Annex B.1](#)). Negative values are reserved for bilateral agreement or protocol extension.

```

PDUType ::= ENUMERATED {
  isdnBchannel      (0),    -- see BearerCapability parameter
  isdnDchannel      (1),    -- intermixed Q.931, Q.932, and X.25
  ip                 (2),    -- Internet protocol packets
  ppp                (3),    -- Internet point-to-point protocol packets
  x25                (4)    -- X.25 LAPB packets
}

```

See “[CCOpen Message](#)” on page 65.

6.4.11 RedirectedFromInformation

The RedirectedFromInformation parameter is used to report information about the last redirecting party and the original redirecting party on calls that are redirected to the subject.

```

RedirectedFromInformation ::= SEQUENCE {
  lastRedirecting    [0] PartyIdentity                OPTIONAL,
-- include if known
  originalCalled     [1] PartyIdentity                OPTIONAL,
-- include if known
  numRedirections    [2] INTEGER (1..100)              OPTIONAL
-- include if known
}

```

See “[TerminationAttempt Message](#)” on page 73.

6.4.12 TerminalDisplayInfo

The TerminalDisplayInfo parameter is used to report information that is displayed on the intercept subject's terminal. The TerminalDisplayInfo parameter shall be encoded as follows:

```
TerminalDisplayInfo ::= SEQUENCE {
    generalDisplay      [0] VisibleString (SIZE (1..80))      OPTIONAL,
    calledNumber       [1] VisibleString (SIZE (1..40))      OPTIONAL,
    callingNumber      [2] VisibleString (SIZE (1..40))      OPTIONAL,
    callingName        [3] VisibleString (SIZE (1..40))      OPTIONAL,
    originalCalledNumber [4] VisibleString (SIZE (1..40))    OPTIONAL,
    lastRedirectingNumber [5] VisibleString (SIZE (1..40))   OPTIONAL,
    redirectingName    [6] VisibleString (SIZE (1..40))      OPTIONAL,
    redirectingReason  [7] VisibleString (SIZE (1..40))      OPTIONAL,
    messageWaitingNotif [8] VisibleString (SIZE (1..40))      OPTIONAL
}
```

See “NetworkSignal Message” on page 68.

6.4.13 TimeStamp

The TimeStamp parameter identifies the date and time of access.

```
TimeStamp ::= GeneralizedTime
```

6.4.14 TransitCarrierIdentity

The TransitCarrierIdentity parameter identifies an interexchange carrier.

```
TransitCarrierIdentity ::= VisibleString (SIZE (3..7))
    -- the carrier access code (if applicable) and carrier identification
    -- code e.g., "123" or "10123" or "1012345" or "9501234"
END
```

6.5 CCC Protocols

6.5.1 CCC Encoding for Circuit-Mode Services

Call content shall be encoded on CCCs using a standard or widely used network bearer services. The intercepted content shall be delivered without modifying the content within the quality objectives for the intercepted network bearer service. Speech and 3.1 kHz audio bearer services intercepted and delivered over circuit-mode digital facilities shall use the μ -law encoding of ITU-T Recommendation *G.711, Pulse Code Modulation (PCM) of voice frequencies*.

Signaling on the CCC or out-of-band signaling may be used to inform the LEA when call content is being delivered.

6.5.2 CCC Encoding for Packet-Mode Services

Intercepted packet-mode data communications shall be delivered to an LEA when a CCC is used by forwarding the intercepted Protocol Data Units (PDUs) employing a standard or widely used protocol. The intercepted PDUs shall include sufficient addressing information to associate the PDU with the parties of the communication. The intercepted PDUs shall be delivered without modification, except for possible re-framing, segmentation, or enveloping required to transport the information to the Collection Function.

The choice of packet delivery protocol is determined at the time that the intercept is provisioned. This delivery method remains in effect until changed by subsequent provisioning.

6.6 LAESP Compatibility Guidelines

The guidelines ensure that there is no long term impediment to the evolution of networks and the implementation of significant new functionality.

6.6.1 Guidelines For Forward Compatibility

When developing a new protocol or enhancing an existing protocol, it is important to remember that a node using one version of protocol may, in the future, need to communicate with nodes using the enhanced version of the basic protocol. Hence, the protocol should be easy to enhance (e.g., easy to add new optional parameters). In addition, procedures should be built into the existing protocol to handle the situations when new messages, known messages with unknown parameters, or known parameters with unknown codes are received.

All revisions of this Interim Standard shall contain a mechanism for forward compatibility. The following list contains the basic requirements of the mechanism:

- a. When the LAESP message is received and it contains all the required parameters, the additional parameters in the received message, known or unknown, may be ignored. The received message should not be rejected because of the unknown parameters in it. In cases that the received message should be relayed to another node, the additional parameters should be passed unchanged.
- b. For existing protocols, state the action to be taken on receipt of spare or reserved values of defined parameters (e.g., treat as appropriate default values, transmit them unchanged at the intermediate nodes, and ignore them at the end nodes).
- c. State that all new messages shall have the ability to add new optional fields.
- d. Unallocated codes of defined fields should be examined and handled as either spare codes or a default code.

6.6.2 Guidelines For Backward Compatibility

When enhancing an existing protocol, it is important to keep in mind that a node using one version of a protocol may need to communicate with nodes using older versions of the same protocol. Hence, the protocol should not be changed abruptly into a form which the earlier protocol versions cannot even interpret. For example, one should not change a fixed length mandatory parameter to an optional parameter in an existing message.

All revisions of this Interim Standard shall contain a mechanism for backward compatibility. The following list contains the basic guidelines to be included.

6.6.2.1 Existing Messages

- a. The ability of receiving any existing messages shall be possible, since the removal of a message implies the removal of a function.
- b. The effect of receiving any existing message, parameter, or function in a new version, must be the same as that in previous versions. The effects of new parameters or parameter values will thus be purely additive.

6.6.2.2 Parameters in Existing Messages

Message parameters in the Parameter Set consist of 2 basic types, mandatory and optional, and need not occur in a pre-defined order. All mandatory and optional parameters have variable length, although some parameters may have their length restricted.

The following guidelines shall apply:

- a. Optional parameters shall not become mandatory.
- b. Mandatory parameters shall not become optional.

- c. Additional mandatory parameters shall not be added to an existing message.
- d. Additional optional parameters can be added to an existing message.
- e. Existing mandatory parameters shall not be removed from existing messages.
- f. The range of any parameter for an existing message shall not be reduced.
- g. The meaning of any defined parameter value shall not be changed on an existing message.
- h. There are no restrictions on the parameters for new messages.
- i. The sequence of parameters in an existing SEQUENCE type shall not be changed.
- j. New parameters may be added to the end of an existing SEQUENCE type. (The value of the parameter identifiers used may be in any order to allow addition of existing parameters to an existing SEQUENCE type.)
- k. New parameters may be added to an existing CHOICE type, unless the CHOICE is mandatory.

6.6.2.3 New Messages

New messages may be added after a Interim Standard has been published; however, nodes that do not recognize these new messages will ignore them, internally indicating that the information was not recognized.

6.6.2.4 New Parameters

New optional parameters can be added to existing messages after a Interim Standard has been published; however, nodes that do not recognize these new parameters may ignore them.

6.6.2.5 New Parameter Fields

New fields may be added to, or spare fields may be used in existing parameters; however, nodes that do not recognize these new fields may ignore these fields.

6.6.2.6 New Parameter Values

Previously spare, reserved, or unallocated parameter values can be used. These will be treated at the receiving node as defined in [Item b](#) of [Section 6.6.1](#).

Annex A Deployment Examples

This Annex is informative and is not considered part of this Interim Standard.

A.1 Possible Network Deployment of IAPs

IAPs may be implemented at a variety of points within a network, depending on the particular telecommunication equipment's architecture, the features and services that are being monitored, and the impact the monitoring at the selected point may have on normal call operation. Generally, it may be assumed that the primary location of the major IAPs are located in the network equipment shown in Table 17.

Table 17: IAP Primary Locations

IAP	Primary Equipment Location
CIAP	Circuit-mode switch
IDIAP	Circuit-mode or packet-mode switch
PDIAP	Packet-mode switch
SSIAP	Home Location Register

It is, however, possible to locate these IAPs within other types of equipment. It should be understood that an IAP placed in a node not corresponding to the primary type of equipment may provide reduced functionality.

For land line subscribers Figure 11 depicts a possible deployment where the access points are in several different pieces of equipment.

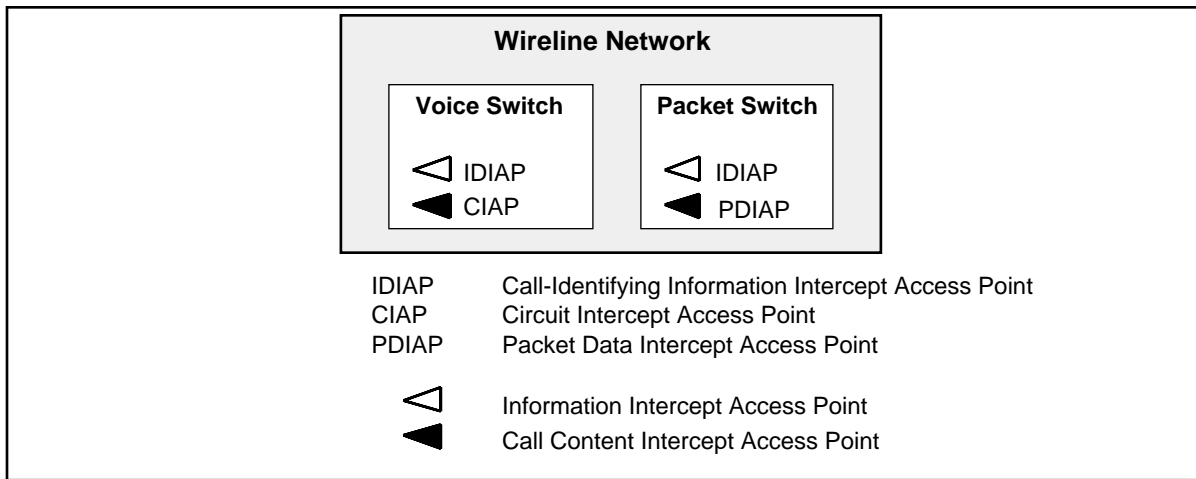

Figure 11: Land Line IAPs

Mobile telephony is more complex. The IAPs for a given intercept subject may be spread across several different clusters of equipment. There is a cluster of equipment at the intercept subject's home and there is another cluster of equipment around the system providing service to the intercept subject. These two clusters may be one and the same, but the more general

PN-4465-RV1

problem is when they are separate. Indeed for some TSPs, these clusters are always separated.

Figure 12 shows possible IAPs deployed in a mobile intercept subject's home equipment cluster.

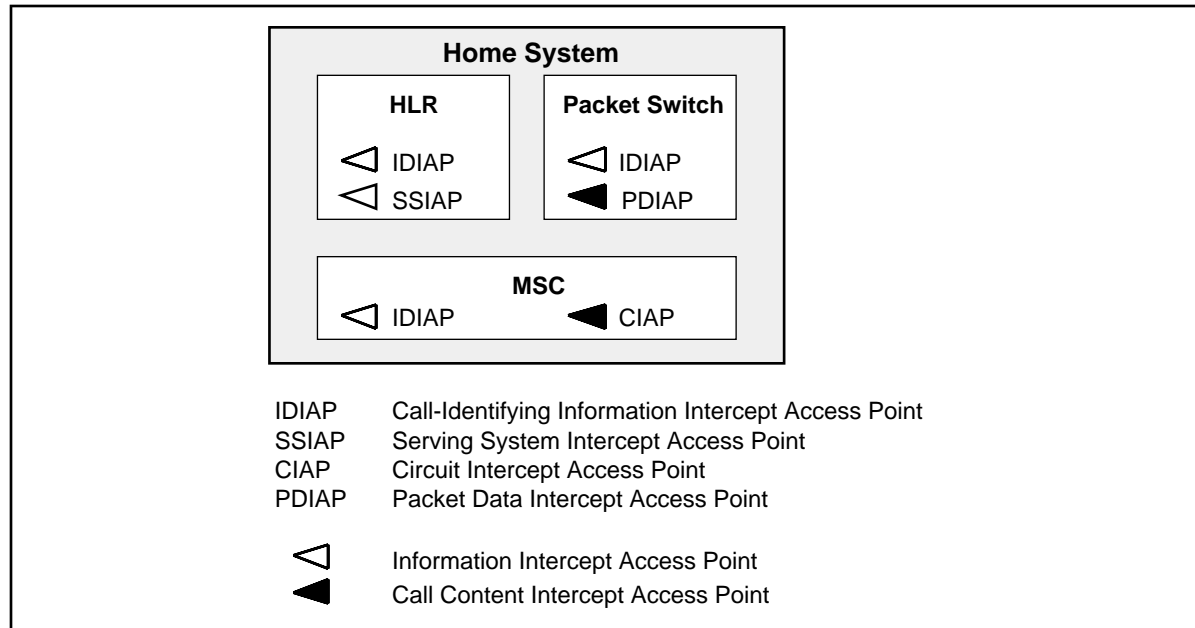

Figure 12: Mobile Intercept Subject's Home System IAPs

Figure 13 shows possible IAPs deployed in a mobile intercept subject's Serving System equipment cluster.

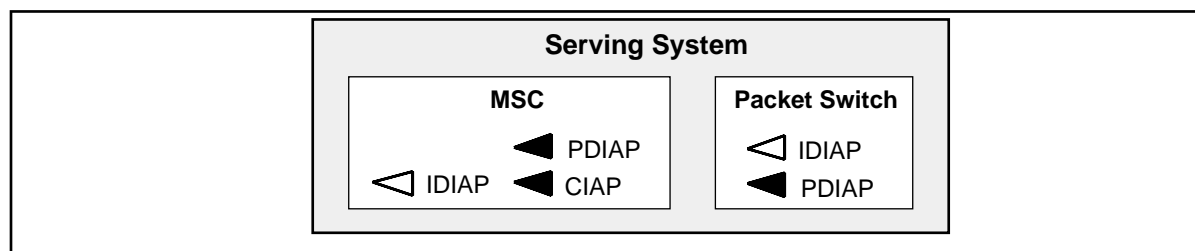

Figure 13: Mobile Intercept Subject's Serving System IAPs

PN-4465-RV1

1
2
3
4
5
6
7
8
9
10
11
12
13
14
15
16
17
18
19
20
21
22
23
24
25
26
27
28
29
30
31
32
33
34
35
36
37
38
39
40
41
42
43
44
45
46
47
48
49
50
51
52
53
54
55
56
57
58
59

When the Redirecting System is a system other than the intercept subject's Home System, it may be desirable to access all of these Redirecting Systems to gain access to the call content of calls intended for the intercept subject. Figure 14 shows possible IAPs.

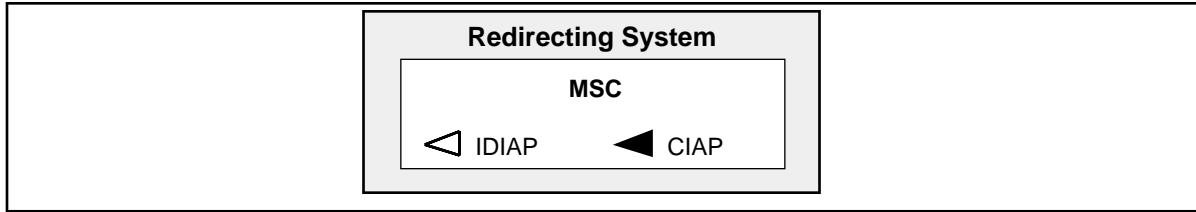

Figure 14: Mobile Intercept Subject's Redirecting System IAPs

A.2 Access and Delivery Function Equipment Configuration

There are several switching equipment configurations possible for intercept functions.

One method is to use an external Delivery Function as shown in Figure 15.

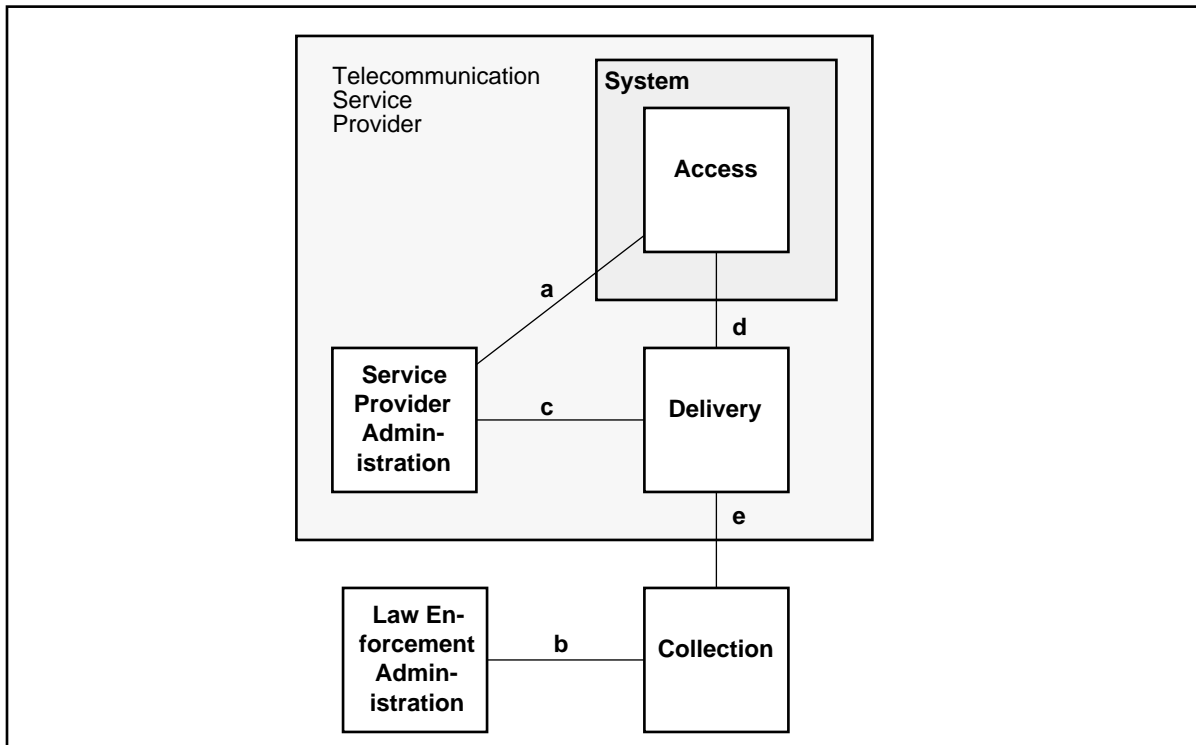

Figure 15: External Delivery Function

The Delivery Function may be integrated into the switch itself. There are two basic variations on this theme dealing with how separate and distinct the administration interfaces remain. These are shown in Figure 16 and Figure 17.

PN-4465-RV1

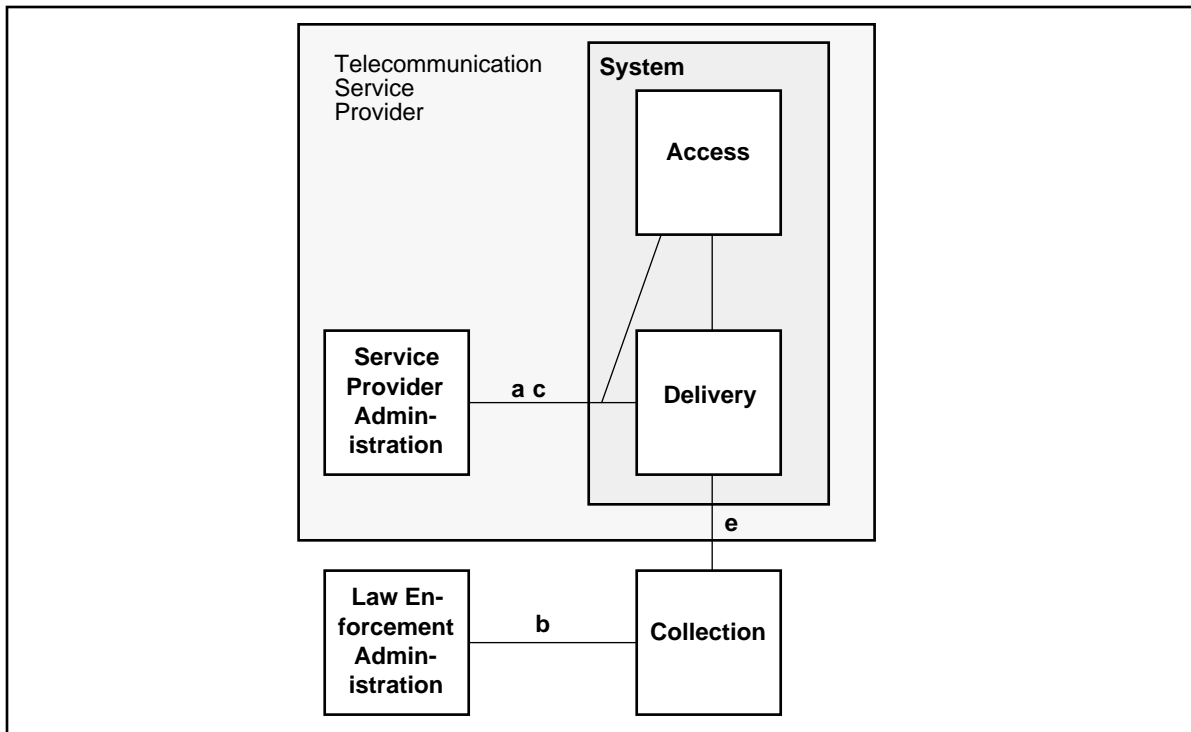

Figure 16: Integrated Delivery Function with a Non-Distinct Administration Interface

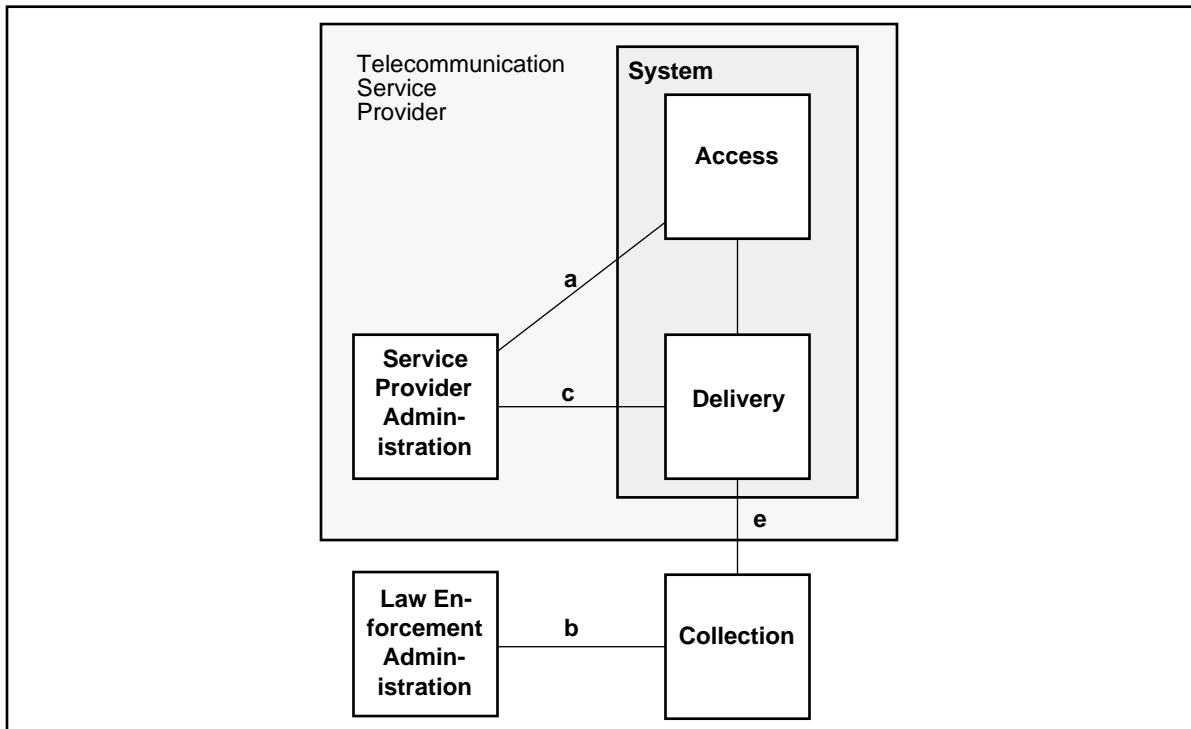

Figure 17: Integrated Delivery Function with a Distinct Administration Interface

PN-4465-RV1

1
2
3
4
5
6
7
8
9
10
11
12
13
14
15
16
17
18
19
20
21
22
23
24
25
26
27
28
29
30
31
32
33
34
35
36
37
38
39
40
41
42
43
44
45
46
47
48
49
50
51
52
53
54
55
56
57
58
59

Mobile telephone systems may involve separate home and serving TSPs. This situation is shown in Figure 18.

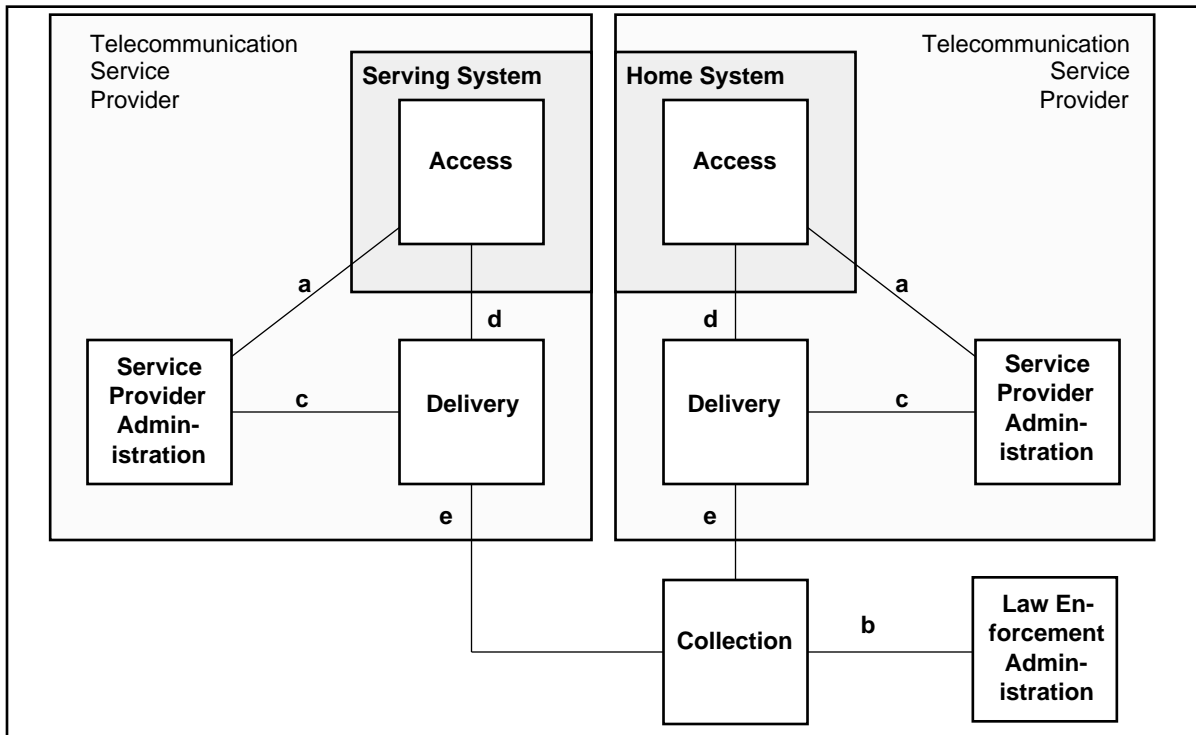

Figure 18: Mobile Telephone Systems with Two TSPs

Mobile telephony may elect to use pivoted delivery when a single TSP controls the Home and Serving Systems, where the CDCs and CCCs are centralized in a Delivery Function before interfacing the Collection Function. This allows a single point to control the information delivered to the Collection Function.

PN-4465-RV1

Figure 19 shows pivoted delivery where two totally independent systems are used. (Note: e_{bis} is an e -interface protocol used between two delivery boxes.)

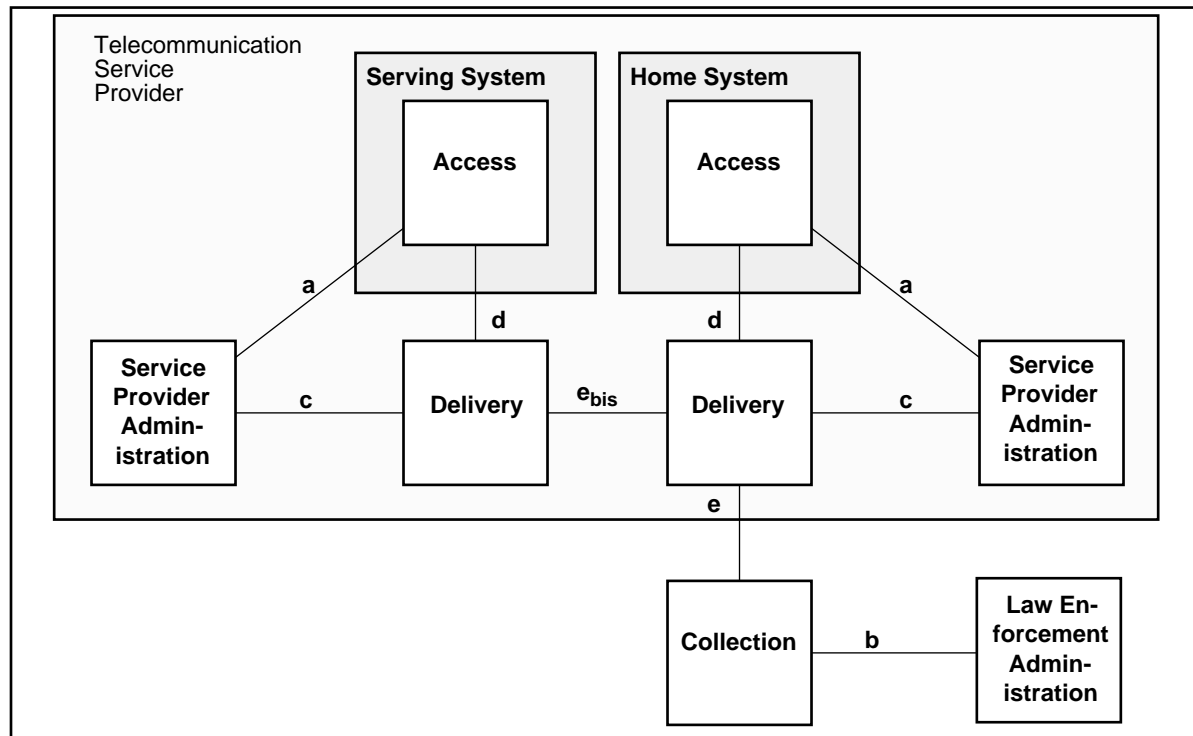

Figure 19: Independently Administered External Pivoted Delivery

A.3 Implementation of the d -interface

The CDC should support all of the IAPs within the interfaced Access Functions. This means that if something is required for a particular Access Function, it should be provided on the corresponding d -interface. For example, if an Access Function supports a Call-Identifying Information IAP (IDIAP) for an HLR, only the incoming calls and originating calls known to the HLR need to be reported. Even though the IDIAP allows for the reporting of all user signaling, the HLR IDIAP need only report the signaling to which it has access.

Any given Delivery Function need only provide one CCC delivery method. The delivery method chosen depends upon local economic, policy, and technical factors. For example, using dedicated circuits is appropriate to installations already having them and for smaller systems in future installations. A trunk group offers some efficiencies which may reduce costs on larger systems. A static directory number, although it may have questionable complexity, may technically provide the interface.

The Delivery Function should not generate call-identifying data and call content on its own, so there is little difference in the call associated and non-call associated messages from the IAPs. All of the call content should come across the d -interface. The Delivery Function may resolve interface differ-

PN-4465-RV1

1
2
3
4
5
6
7
8
9
10
11
12
13
14
15
16
17
18
19
20
21
22
23
24
25
26
27
28
29
30
31
32
33
34
35
36
37
38
39
40
41
42
43
44
45
46
47
48
49
50
51
52
53
54
55
56
57
58
59

ences between *d*- and *e*-interfaces, so it may need to handle different CCC delivery methods.

If the *d*-interface for the CCC is within the premises of a TSP, the need for transmission devices and intervening networks may be eliminated and simpler non-error handling protocols may be appropriate.

Accesses may be either bridged or looped. In a bridged access, the communication is accessed directly (e.g., in a time slot interchanger or with a bridging circuit) within the Access Function. Separate circuits are brought out for the transmit and receive paths of the accessed communication, as shown in Figure 20.

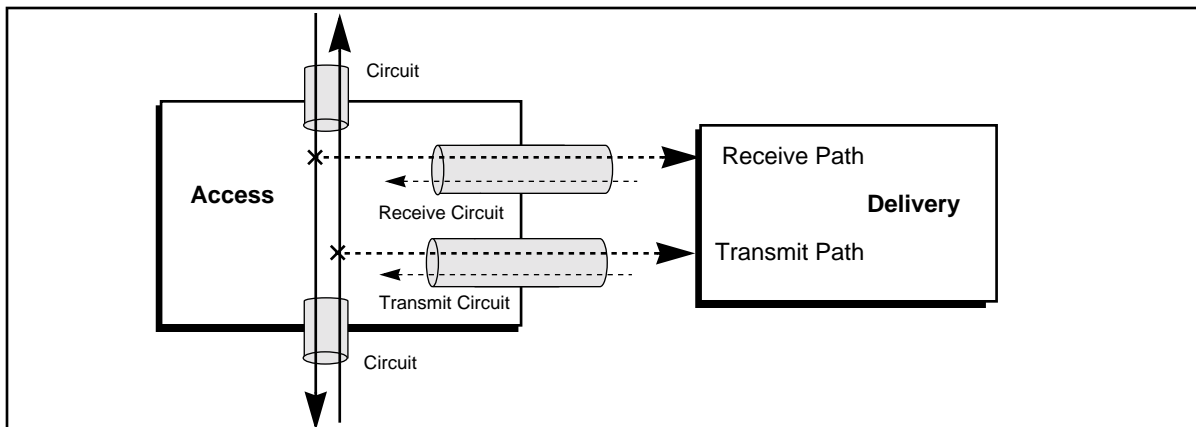

Figure 20: Bridged Access

In looped access the accessed communication is switched out of the Access Function as a circuit, looped through the Delivery Function and back into the Access Function, as shown in Figure 21. The Delivery Function is responsible for accessing the communication from the looped circuit and not disrupting the looped communication.

The bridged and looped access methods are considered to be logically equivalent, even though they have different physical implementations. They both access the intercept subject's transmit and receive communication paths.

If a subscriber's communications are combined, then combined delivery from the Access Function is sufficient. Even though some communications (e.g., speech and 3.1 kHz audio) are fully separated, combined delivery may still be appropriate since the communications must work even when communicating with an interface that supports only combined delivery. Even though combined delivery is sufficient, separated delivery is technically possible, but may not be economically viable.

Separated delivery on the *d*-interface allows the combining to take place in the Delivery Function. Combined delivery may be provided on the *d*-interface if all communications accessed by the IAP are by nature combined. There is some middle ground for the decision to be made on a per call basis using the negotiated bearer capability. The Combining can take place on either the Access or Delivery Function, provided that the communications that require separated delivery are not combined.

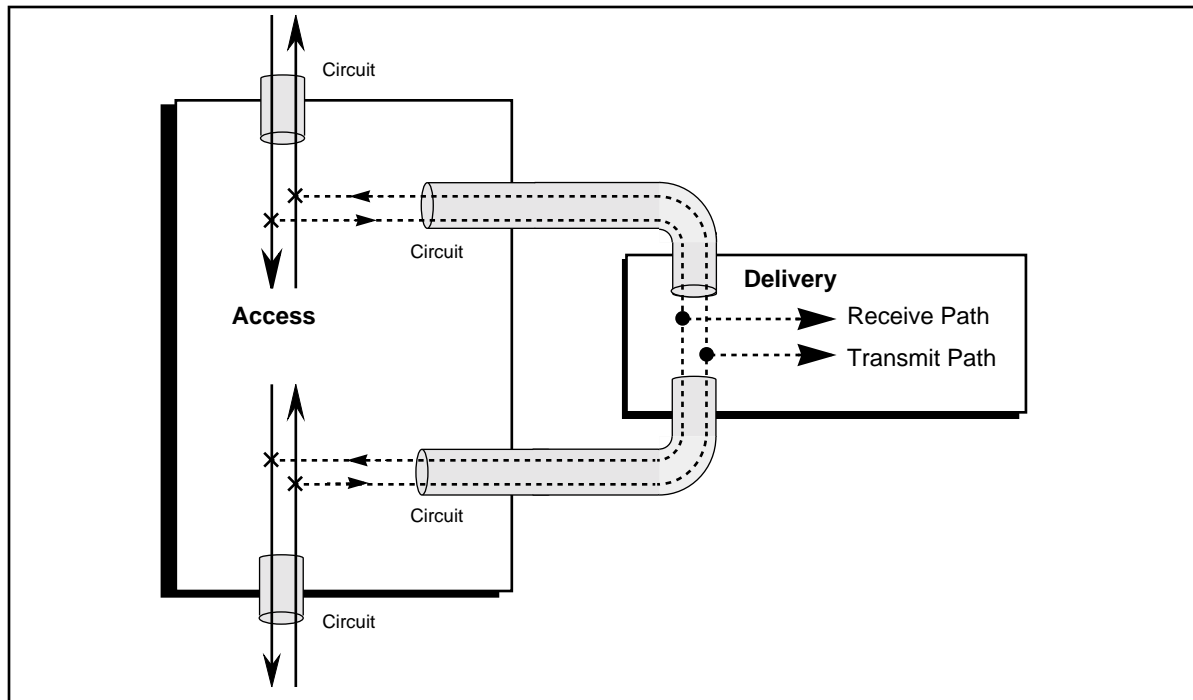

Figure 21: Looped Access

The bottom line for the choices is that they are subject to implementation decisions based on economic and TSP policy. It is likely that large systems may have different implementations than small systems.

A.4 Implementation of the e-interface

Any given Delivery Function need only provide one CCC delivery method. The delivery method chosen depends upon local economic, policy, and technical factors. For example, using dedicated circuits is appropriate to installations already having them and for smaller systems in future installations. Static directory numbers allows for some savings in the number of trunks required on the Delivery Function and Collection Function. Trunk groups may offer some savings for some installations.

When the e-interface is implemented between the Delivery Function and the Collection Function, there may be a number of different protocols used in the interface. This is because there may be intervening networks and specialized transmission devices (e.g., modems, DSUs, CSUs). The intervening network allows the LEA to procure its communication services from a TSP other than the TSP providing the Access Function. Transmission devices allow carriage of information which may not otherwise be possible (e.g., using a modem to carry data over an analog facility).

PN-4465-RV1

1
2
3
4
5
6
7
8
9
10
11
12
13
14
15
16
17
18
19
20
21
22
23
24
25
26
27
28
29
30
31
32
33
34
35
36
37
38
39
40
41
42
43
44
45
46
47
48
49
50
51
52
53
54
55
56
57
58
59

Figure 22 shows a few possibilities of the use of different transmission schemes on the e -interface. In general, the interface protocol provided by a Delivery Function (at the e -interface) need not be the same as the interface at the Collection Function (at the e_4 -interface). The interface protocol stack for each interface is chosen at the agreement of the two ends of the transmission line. Only when there is a direct physical connection between the Delivery Function and the Collection Function should the interface protocols be the same.

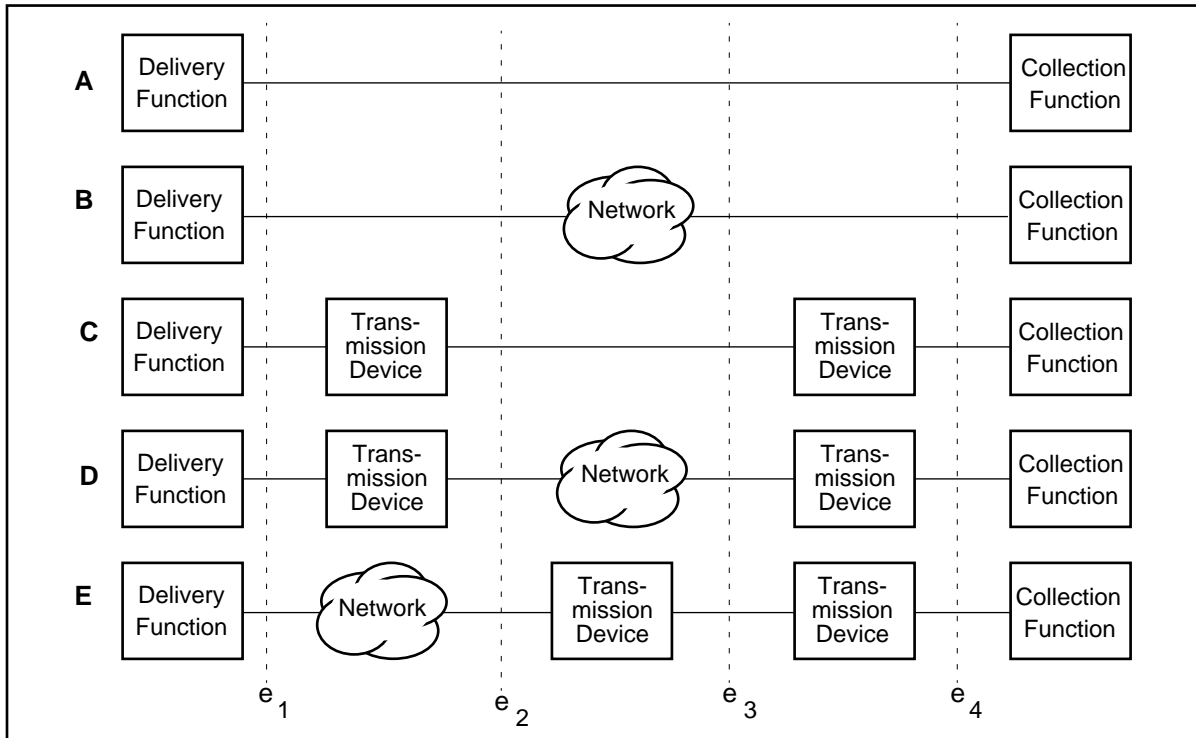
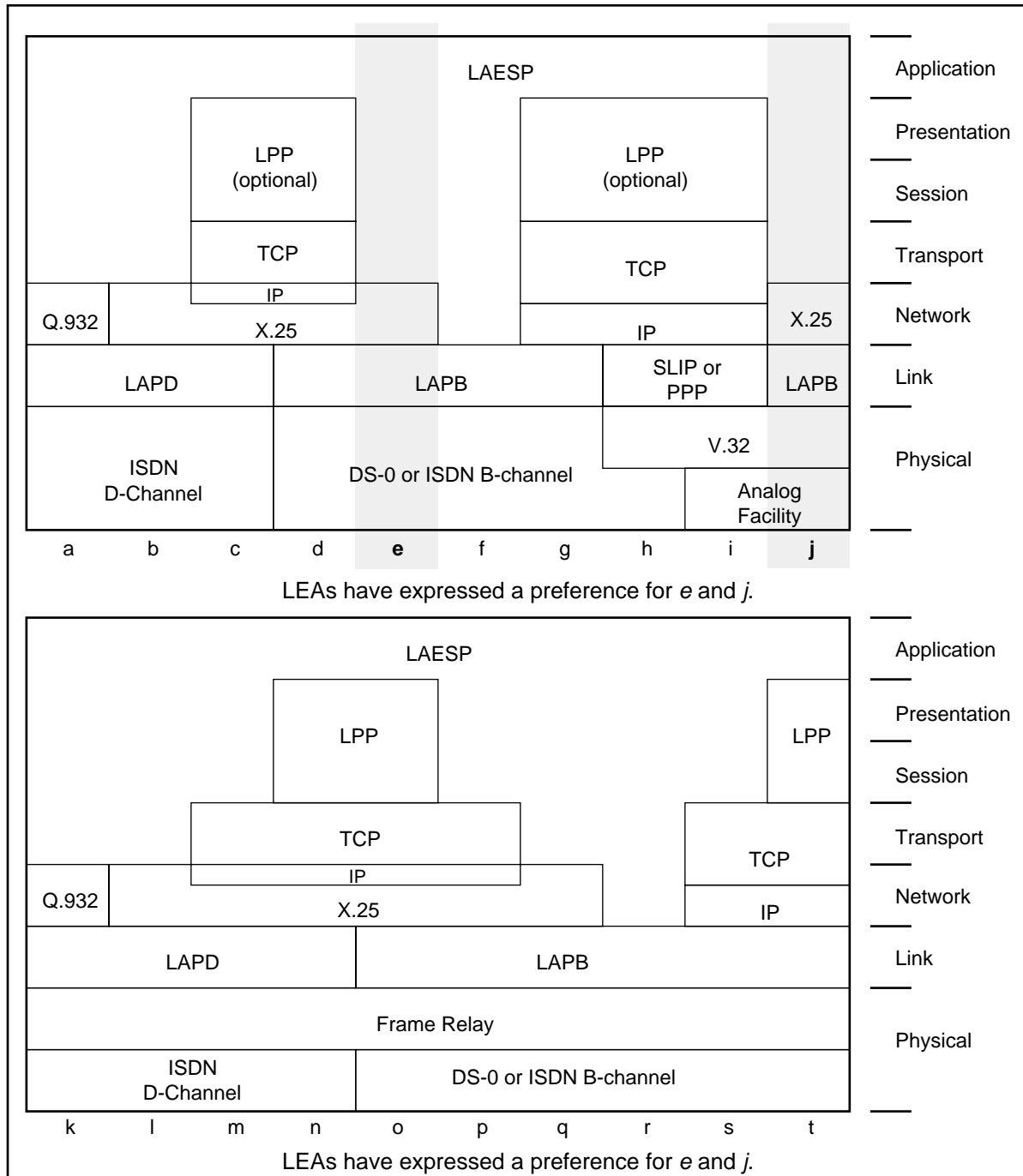

Figure 22: Possible Transmission Schemes for the e -Interface

PN-4465-RV1

A.5 Possible CDC Protocol Stacks

Figure 23 illustrates possible CDC Protocol Stacks. These are not meant to be definitive or exhaustive, but rather illustrative.



PN-4465-RV1

1
2
3
4
5
6
7
8
9
10
11
12
13
14
15
16
17
18
19
20
21
22
23
24
25
26
27
28
29
30
31
32
33
34
35
36
37
38
39
40
41
42
43
44
45
46
47
48
49
50
51
52
53
54
55
56
57
58
59

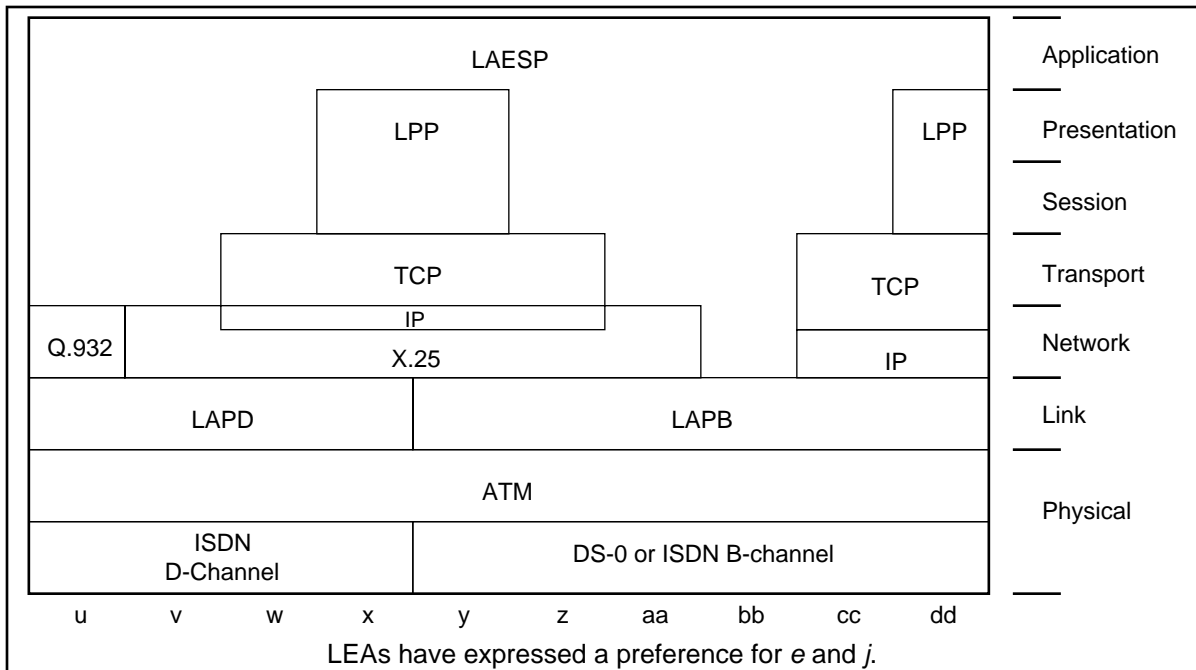

Figure 23: Possible CDC Protocol Stacks (Sheet 3 of 3)

Dedicated data circuits should be used when delivery delay is of utmost importance.

Dedicated data links should be used where communication resources may be combined for a single destination.

Packet switched links should be used where communication services may be combined and packet switching services are available.

A.6 Possible CCC Protocol Stacks

Figure 24 illustrates possible CCC Protocol Stacks. This is not meant to be definitive or exhaustive, but rather illustrative.

Dedicated circuits are used when no call content delivery delay can be tolerated and in traditional intercept arrangements. Dedicated circuits may require a long lead time to establish a connection. Additional subscribers may not be added to a dedicated circuit, although dedicated circuits may be provisioned before they are needed.

Trunk groups may be used when some call content delivery delay can be tolerated and there is a high volume of call content deliveries between two points. A trunk group with excess capacity may be used by a new intercept subject without additional provisioning. Circuits may be added to a trunk group as necessary. Each intercept subject may be assigned a minimum number to reserve an intercept capacity for the intercept subject. The sum of the minimums should not exceed the capacity of the trunk group. Each intercept subject may also be assigned a maximum to limit the number of circuits that an intercept subject may use. This requires the trunk group to

PN-4465-RV1

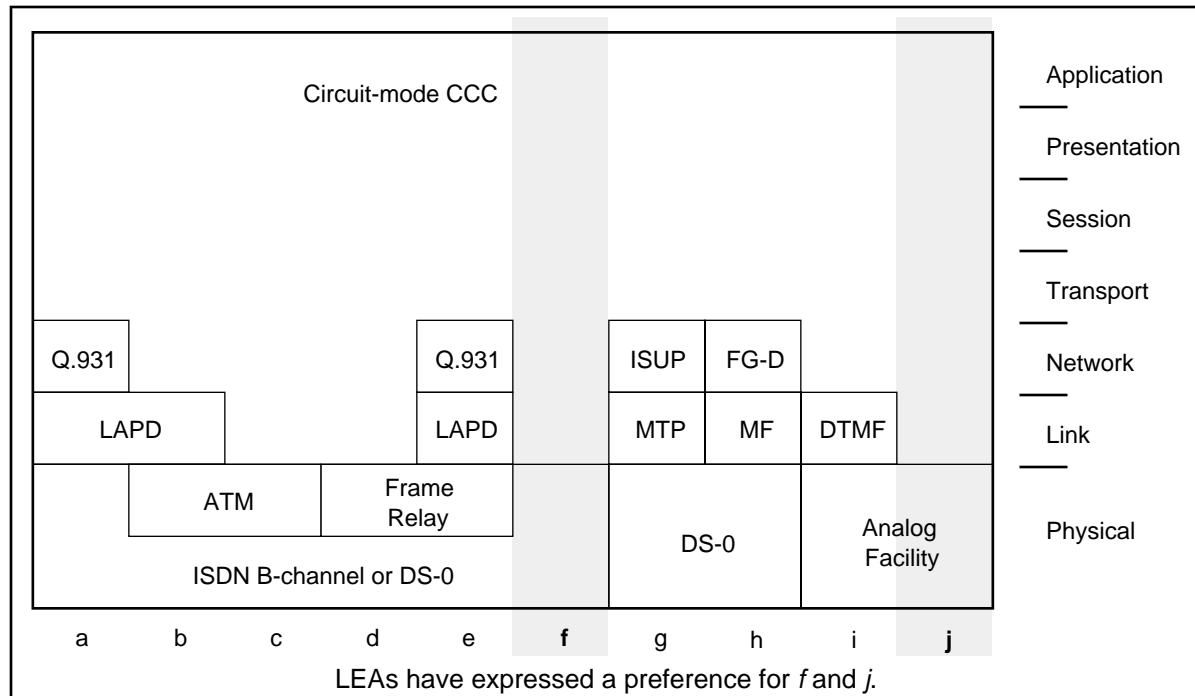

Figure 24: Possible Circuit-Mode CCC Protocol Stacks

have some excess capacity. This engineering is the same on both sides of the trunk group.

Static directory numbers may be used when some call content delivery delay can be tolerated and a high flexibility for provisioning intercepts is desired. Static directory numbers on the source side use a common trunk group. Adding a trunk to a source is independent of adding a trunk to a destination. Trunks may be added at will. Intercept may also be added provided there is enough excess capacity. Each intercept subject may be assigned a minimum number to reserve an intercept capacity for the intercept subject on the source side. This same number should be reserved on the destination side. The sum of the minimums should not exceed the capacity of the trunk group. Each intercept subject is assigned a maximum number of circuits. The number of circuits on the destination side should at least be equal to the sum of the minimums, and the maximum should allow for whatever excess capacity is desired to prevent blocking. The engineering is different on source and destination sides. Blocking may occur on other side.

Packet-mode content may be delivered over the CDC (for a small number of packet types). Other packet-mode content should be delivered using CCCs, possibly over a packet data network, as shown Figure 25. Dedicated facilities or subnetworks may be used between the PDIAP and the LEA to provide appropriate levels of security and throughput.

PN-4465-RV1

1
2
3
4
5
6
7
8
9
10
11
12
13
14
15
16
17
18
19
20
21
22
23
24
25
26
27
28
29
30
31
32
33
34
35
36
37
38
39
40
41
42
43
44
45
46
47
48
49
50
51
52
53
54
55
56
57
58
59

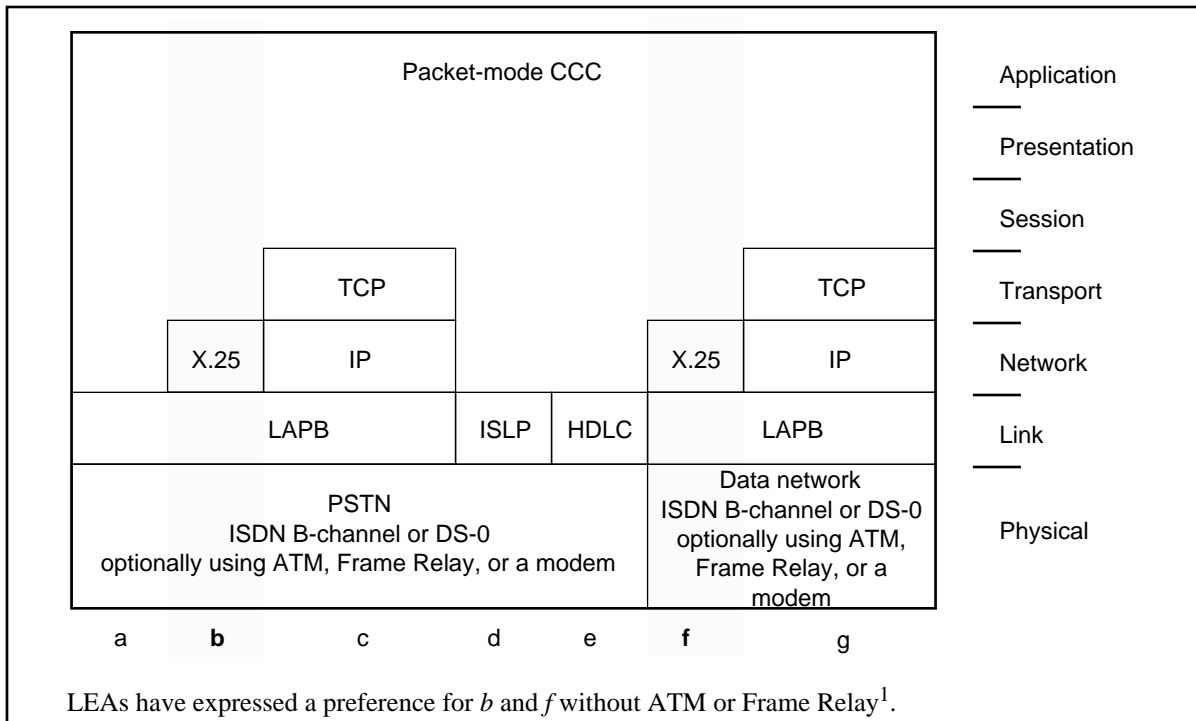

Figure 25: Possible Packet-Mode CCC Protocol Stacks

-
1. The packet delivery rate of IP encapsulated in X.25 and run over an X.25 network may not provide adequate throughput.

PN-4465-RV1

Annex B CCC Delivery Methods

This Annex is informative and is not considered part of this Interim Standard.

B.1 Circuit-Mode vs. Packet-Mode

Circuit-mode communications move call content either as a metallic analog electrical signal or as a constant rate stream of bits. The stream of bits can be conveyed by various mechanisms including an ISDN B-channel, a DS-0, or an ATM circuit (even though ATM has the characteristics of packet-mode communication, it is essentially providing a circuit-mode communication when constant bandwidth is requested). Circuit-mode communications may carry a packetized data service, but that is transparent to the switching system. Digital circuit-mode switches route bit streams to their destination. Digital circuit-mode intercepts route intercepted bit streams to the authorized LEA.

Packet-mode communications move call content as a variable rate stream of bits conveyed by packets. Packet-mode switches route individual packets to their destination. Packet-mode intercepts route intercepted packets to the authorized LEA.

A circuit-mode communication can be intercepted and delivered only over circuit-mode delivery. This delivery may use dedicated channels (using a channel number) or it may use channels established on demand (using a directory number). Any directory number assigned by an LEA can only be used by one IAP to avoid conflicts and busy treatment.

A packet-mode communication can be delivered over a packet-mode delivery using the same or a different packet delivery protocol. This delivery can use a connectionless service, a permanently established connection-oriented service, or a connection-oriented service established on demand. All packet-mode delivery services require individual network addresses at the LEA to separate call content from various subjects and intercept access points.

A packet-mode communication can also be delivered using a circuit-mode delivery to convey packetized information. The circuit-mode connection may use dedicated channels or it may establish channels on demand. Once the circuit-mode channel is established, the packet-mode contents can be delivered using a packet protocol on top of the circuit-mode channel. This packet delivery protocol can be defined by mutual agreement between the LEA and the TSP or the protocol can be identified by the Bearer Capability in the SETUP message when ISDN is used end-to-end. The same delivery channel can be used for both circuit-mode and packet-mode delivery as indicated by the presence of [CallIdentity](#) or [PDUType](#) parameters in the [CCOpen](#) message.

In all cases of packet-mode intercepts, the type of packet-mode communication being intercepted is communicated by the [PDUType](#) parameter in the [CCOpen](#) message. Circuit-mode intercept of packet communications are identified by the [BearerCapability](#) parameter in various LAESP messages.

B.2 Overview

This annex describes the CCC delivery service as a set of mechanisms, characteristics, and options that may be considered when selecting a CCC delivery method:

- a. A CCC delivery method defining the overall signaling protocol:
 - Dedicated Circuit (see B.3);
 - Trunk Group (see B.4);
 - Static Directory Number (see B.5); or
 - Packet Data (see B.6).

The Access Function and the Collection Function shall support at least one delivery method. More than one technique may be supported for implementation richness or for failure backup and for handling of overloads of individual intercepts.

- b. Bearer service for the call content itself (e.g., analog or digital) (see B.7).
- c. Delivering an intercepted communication as separated channels (see B.8) or as a combined channel (see B.9).
- d. Delivery signaling for the CCC (see B.10).
- e. The amount of acceptable end-to-end delay for the particular intercept (see B.11).
- f. Distributing the CCC to more than one Collection Function, each with its own delivery method and options (see B.12).

Intervening functional entities may convert the basic bearer service or the signaling method and may add additional delay.

Call content is delivered between the Access Function (or its IAPs) and the Delivery Function and between the Delivery Function and the Collection Function. The interface for both transfers is sufficiently similar to warrant only a single description. Within this section call content is described generically as being transferred from a *source* to a *destination*.

The delivery of intercepted call content information has several phases. These phases are as follows:

- a. Obtain a network address of destination. Select the destination for the call content as either a destination directory number or a specific directly connected trunk.
- b. Setup the CCC to destination. Establish a channel to the destination to be used for the delivery of call content.
- c. Destination acceptance or refusal of a CCC. The destination is given the option, in some cases, to accept or refuse the CCC.
- d. CCC continuity verification. Verify that the CCC has reached the destination and that it is capable of reliably transferring call content information.

- e. Associate intercept subject and call identity to the CCC. Establish the association of the CCC with the intercept subject, an intercepted call, and an IAP. Recording of the call content by the destination should begin at this point.
- f. Call content transfer. Transfer the intercepted call content. This phase lasts as long as necessary. Information identifying the call content is sent separately.
- g. Early CCC release by the destination. Some delivery methods allow the destination to release the delivery CCC.
- h. Disassociate CCC. Free up the association of the CCC to a particular call and intercept subject to allow it to be used for other purposes.
- i. Normal CCC release by the source.

The information flows described in this section are written for a single CCC. These procedures should be repeated for each CCC used (e.g., for separated delivery).

B.3 Dedicated Circuit CCC Delivery

Dedicated circuit delivery uses one or more circuits to convey the call content for a single intercept subject as shown in Figure 26. Each circuit is dedicated to a particular intercept subject, so that circuit cannot be used for any other purpose. The circuit may be switched through the intervening network(s), but this switching is transparent to the usage of the circuit as the switching occurs when the circuit is provisioned. The intercept subject and the call content are identified with their association to a particular dedicated circuit.

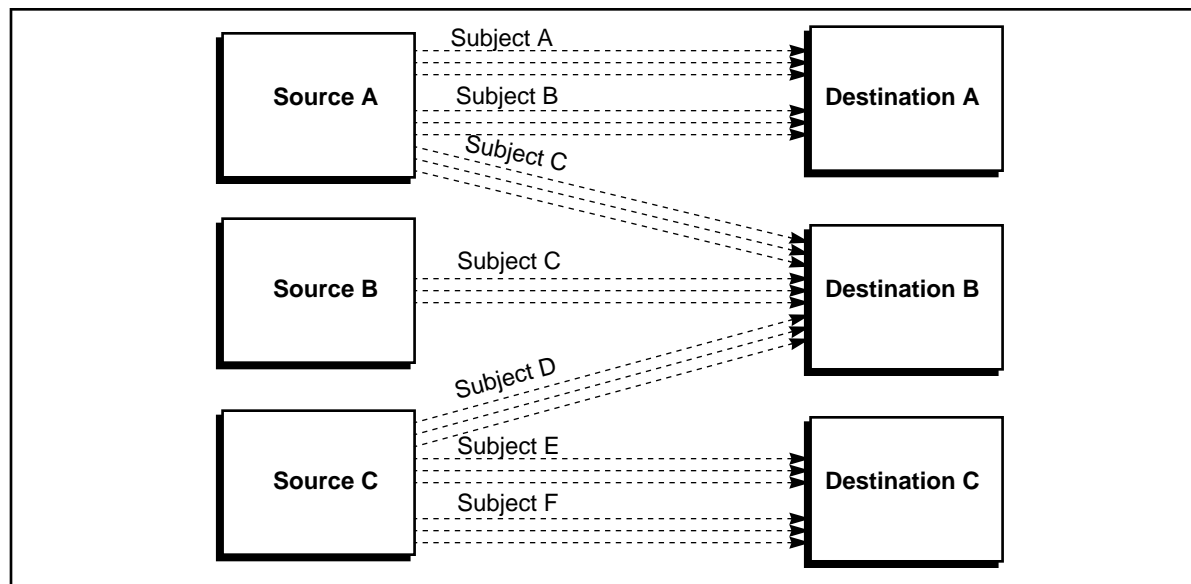

Figure 26: Dedicated Circuit CCC Delivery

Dedicated circuits are circuits between two functions using dedicated equipment on both the source and destination. These circuits may be switched through an intervening network, although call setup procedures do not apply. Dedicated circuits are used in cases where no delivery delay is tolerable.

PN-4465-RV1

Dedicated circuits used for CCCs are assumed to have the following characteristics:

- a. DC signaling is not available end-to-end as intervening switches may ignore and not pass along DC signaling. (DC signaling may be used for direct connections.)
- b. DTMF C-tone may be used to convey DC signaling (i.e., off-hook, on-hook, decadic digits).
- c. A particular dedicated circuit has only one intercept subject assigned to it.
- d. An intercept subject may have one or more circuits available for delivering its call content.
- e. Separate dedicated circuits are required for each intercept subject and destination pair.
- f. The number of dedicated circuits to each Collection Function need not be equal.

B.3.1 Obtain Network Address of Destination

Select an idle circuit from the circuits available for this intercept subject and the selected destination. The selection criteria should use all circuits on a regular basis.

B.3.2 Setup CCC to Destination

No call setup is necessary.

Seize the selected dedicated circuit as shown in [Figure 27](#).

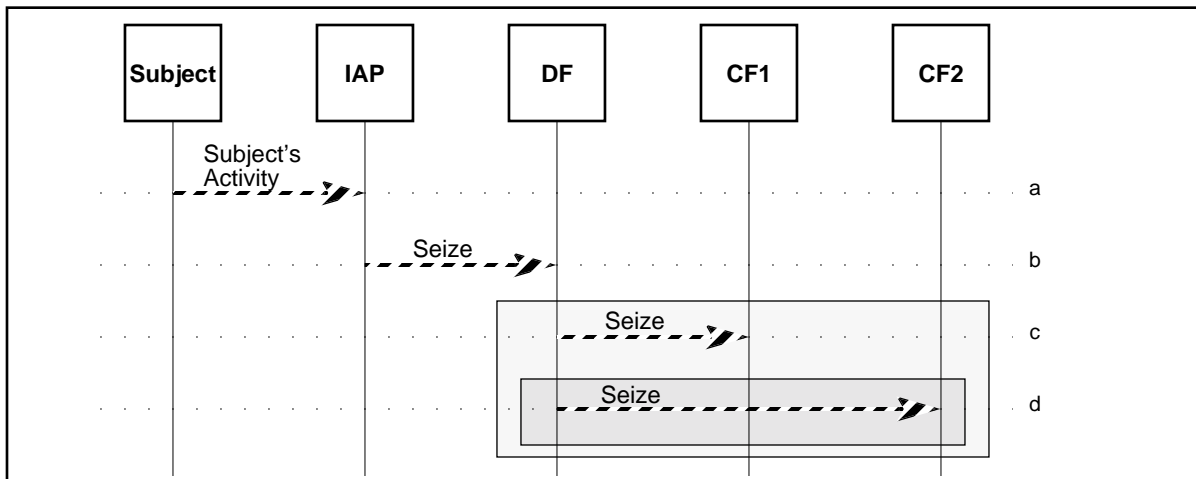

Figure 27: Setup CCC Using Dedicated Circuits

- a. The IAP is enabled and it detects that the intercept subject is communicating (e.g., an origination or termination attempt).
- b. The dedicated circuit is seized to the Delivery Function. This may be indicated with a DC signaling off-hook (when directly connected), by dropping DTMF C-tone, or with a CCOpen message.

PN-4465-RV1

- c. If applicable, the Delivery Function forwards the seizure indication to the dedicated circuit associated with the intercept subject to the Collection Function. The seizure may be indicated with a DC signaling off-hook (when directly connected), by dropping DTMF C-tone, or with a CCOpen message.
- d. Optionally, the Delivery Function may seize dedicated circuits associated with the intercept subject to one or more additional authorized Collection Function.

1
2
3
4
5
6
7
8
9
10
11
12
13
14
15
16
17
18
19
20
21
22
23
24
25
26
27
28
29
30
31
32
33
34
35
36
37
38
39
40
41
42
43
44
45
46
47
48
49
50
51
52
53
54
55
56
57
58
59

B.3.3 Destination Acceptance or Refusal of a CCC

There is no mechanism defined for a destination to accept or refuse a dedicated circuit CCC.

B.3.4 CCC Continuity Verification

While dedicated circuits are idle, DTMF C-tone may be applied to them. The presence of DTMF C-tone may be used to indicate circuit continuity, although it does not verify the source of the circuit or its association with any intercept subject.

PN-4465-RV1

B.3.5 Associate Intercept Subject and Call Identity to the CCC

The intercept subject is associated with a dedicated circuit for the life of the intercept order, so all that is required is to select the particular dedicated circuit or trunk as shown in Figure 28. The CCOpen message may be used to associate a particular call with the dedicated circuit. The CCOpen is particularly required when multiple dedicated circuits for a given intercept subject are used.

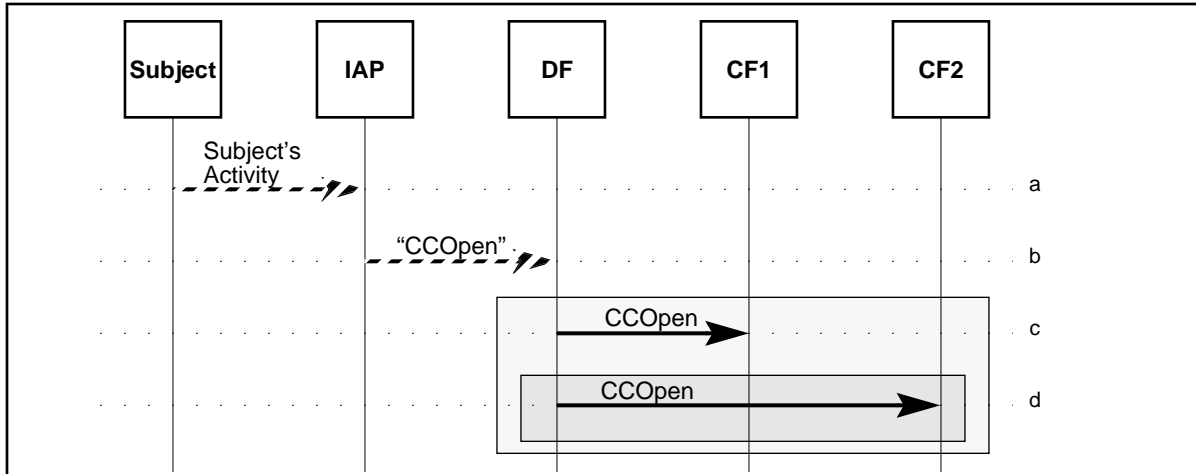

Figure 28: Associate CCC Using Dedicated Circuits

B.3.6 Call Content Transfer

The TSP duplicates the intercepted call content and delivers it to the selected Collection Functions over the CCCs identified in the CCOpen message associated with the intercepted communications as shown in Figure 29.

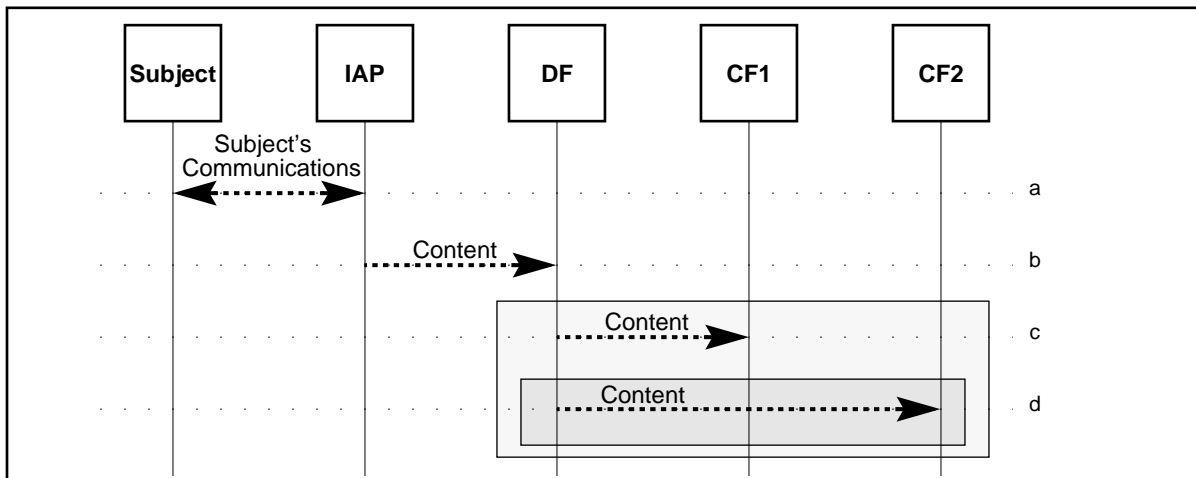

Figure 29: Transfer Call Content Using Dedicated Circuits

- a. The IAP is enabled and it detects that the intercept subject is communicating (e.g., an origination or termination attempt).
- b. The intercept subject's communications are intercepted and duplicated, and sent to the Delivery Function.

PN-4465-RV1

- c. If authorized, the Delivery Function passes the call content on to the Collection Function.
- d. Optionally, the Delivery Function may duplicate the call content and deliver it to one or more additional authorized Collection Functions.

B.3.7 Early CCC Release by the Destination

Dedicated circuits may not be released early by the destination.

B.3.8 Disassociate CCC

The intercept subject is associated with a dedicated circuit for the life of the intercept, however the association for a particular call or intercept may be released with a CCClose message as shown [Figure 30](#).

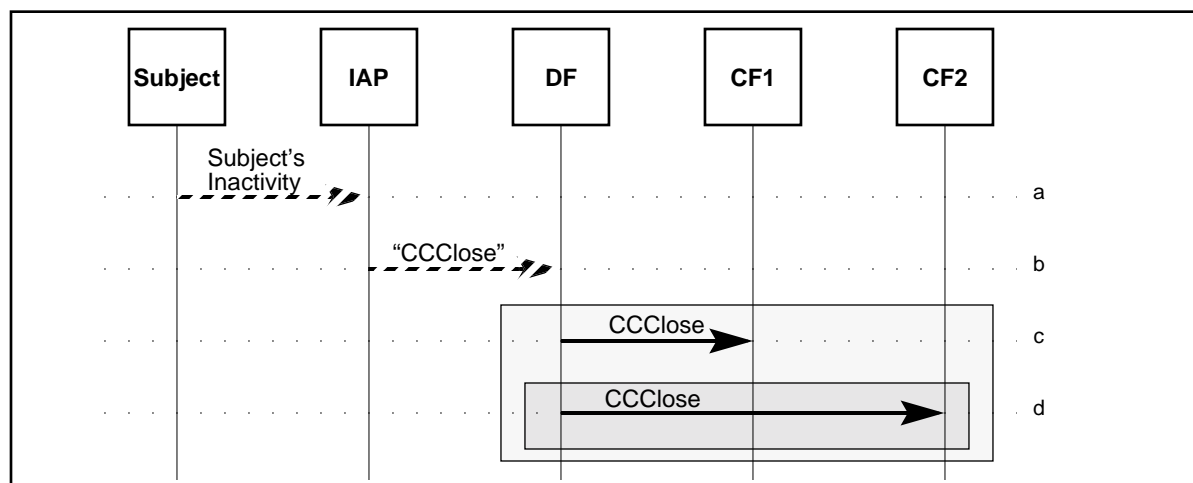

Figure 30: Disassociate CCC Using Dedicated Circuits

B.3.9 Normal CCC Release by the Source.

When a dedicated circuit is released, continuous DTMF C-tone may be applied. The circuit is free for subsequent intercepts of the same intercept subject.

The association of a dedicated circuit to a particular intercept subject and destination is only released when the intercept order is removed or expires as shown in [Figure 31](#).

- a. The IAP is enabled and it detects that the intercept subject has stopped communicating (e.g., the call was released or a party has been dropped).
- b. The dedicated circuit is released to the Delivery Function. This may be indicated with a DC signaling on-hook (when directly connected), by applying DTMF C-tone, or with the CCClose message.
- c. If applicable, the Delivery Function releases the dedicated circuit associated with the intercept subject to the Collection Function with a DC signaling on-hook (when directly connected), by applying DTMF C-tone, or with the CCClose message.

PN-4465-RV1

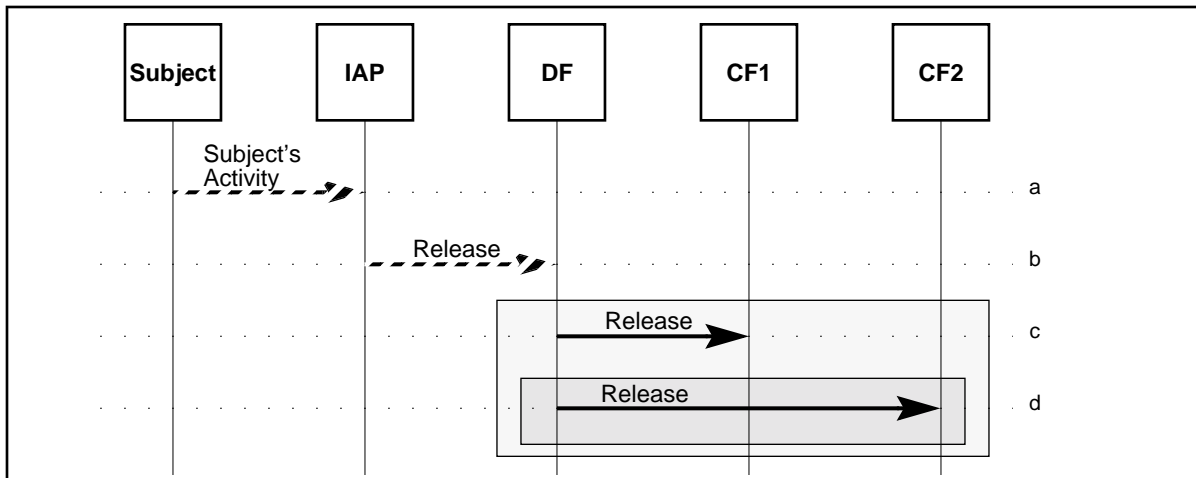

Figure 31: Dedicated Circuit CCC Release

- d. Optionally, the Delivery Function may release the dedicated circuits associated with the intercept subject to one or more additional authorized Collection Functions.

B.4 Trunk Group CCC Delivery

Trunk group delivery uses a set of circuits between two functions to convey call content for a set of subscribers with a common destination as shown in Figure 32. These circuits may be switched on demand through an intervening network at the time of need. A given circuit in a trunk group may be used for any appropriate intercept subject. A line side interface may be part of a trunk group, although that is outside of the classical definition of a trunk group.

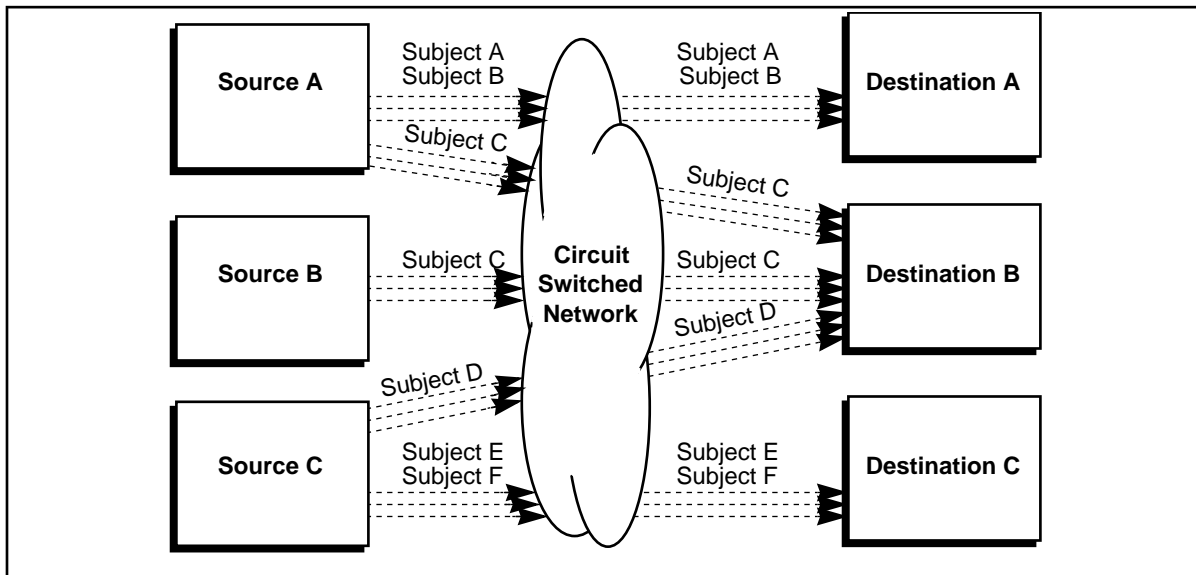

Figure 32: Trunk Group CCC Delivery

PN-4465-RV1

Circuits in a trunk group are assumed to have the following characteristics:

- a. Seize, answer, disconnect and release signals are available using end-to-end (e.g., DC signaling possibly using the DS-0 A signaling bits, ISUP out-of-band signaling, ISDN PRI out-of-band signaling, BRI out-of-band signaling, loop start line signaling). The particular type of signaling used need not be end-to-end as long as it is interworked end-to-end.
- b. There is a one-to-one correspondence between both ends of a trunk group to identify individual trunks within the trunk group.
- c. DTMF C-tone may be used, but it is ignored for the purpose of signaling.
- d. A particular trunk circuit is shared by several intercept subjects.
- e. An intercept subject may use one or more trunk circuits for delivering its call content. The maximum number of circuits may be specified for a given intercept subject.
- f. A trunk group goes to only one destination.
- g. The number of trunk circuits to each Collection Function need not be equal.

B.4.1 Obtain Network Address of Destination

Select the trunk group based on the assigned destination. Select an idle trunk within the trunk group for the particular intercept. The selection criteria should use all trunks in the trunk group on a regular basis.

B.4.2 Setup CCC to Destination

Seize the trunk using appropriate trunk signaling (e.g., signal off-hook with the DS-0 A bits, off-hook on a loop start line, send a SETUP message for an ISDN PRI or BRI, send an Initial Address Message for an ISUP trunk) as shown in Figure 33.

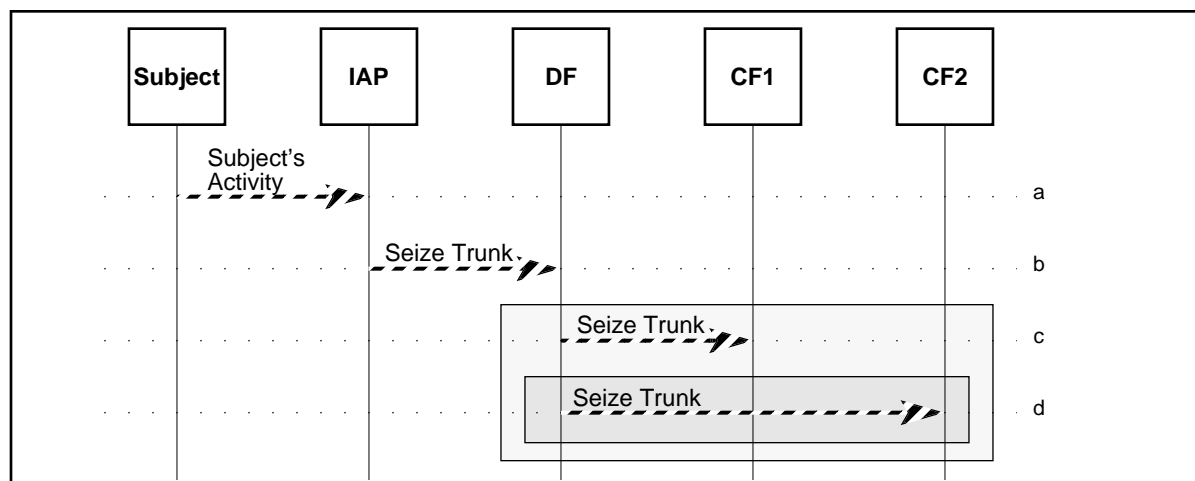

Figure 33: Setup CCCs Using a Trunk from a Trunk Group

- a. The IAP detects that the intercept subject is communicating.

PN-4465-RV1

- b. The IAP sends a signal to seize the trunk to the Delivery Function.
- c. If authorized, the Delivery Function sends a signal to seize the trunk to the Collection Function.
- d. Optionally if authorized, the Delivery Function may send a trunk seizure signal to one or more additional Collection Functions.

B.4.3 Destination Acceptance or Refusal of a CCC

A trunk may be accepted by answering the trunk setup signaling (e.g., return an off-hook with the DS-0 A bits, go off-hook on a loop start line, send a Connect message for an ISDN PRI or BRI, send an Answer Message for an ISUP trunk) as shown in Figure 34.

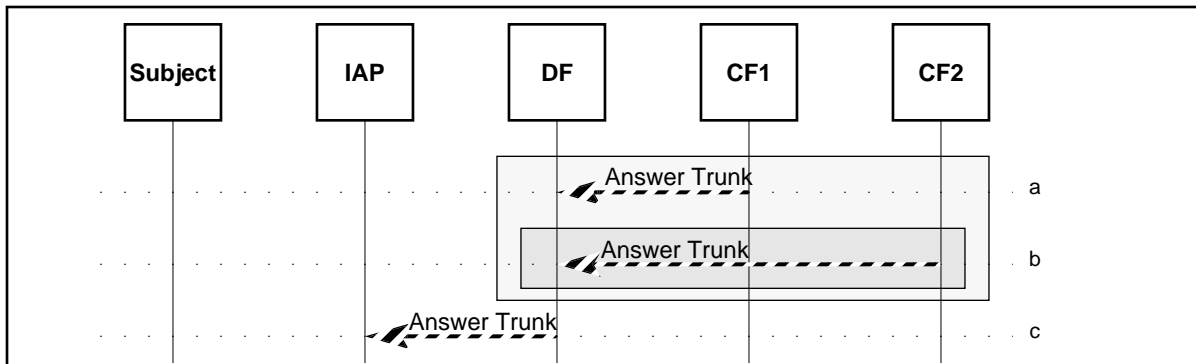

Figure 34: Acceptance of CCCs Using a Trunk of a Trunk Group

- a. When the trunk is seized at the Collection Function, it may accept the call by returning an answer indication.
- b. Each additional Collection Function trunk seized may return an answer indication.
- c. If the call is accepted by the Delivery Function, it may return an answer indication to the IAP.

A trunk may be refused by not answering the seize signal as shown in Figure 35 and Figure 36. If the expected answer signal does not arrive in time, the source assumes that the call was refused and proceeds to release the trunk circuit. A refusal by one Collection Function shall not prevent the delivery of call content to other Collection Functions.

- a. When a trunk is seized by the IAP, an answer timer is started.
 - b. The answer timer expires, indicating that the call was refused, and...
 - c. ...the IAP releases the trunk toward the Delivery Function.
- a. When a trunk is seized by the Delivery Function, an answer timer is started.
 - b. The answer timer expires, indicating that the call was refused, and...
 - c. ...the Delivery Function releases the trunk toward the Collection Function.

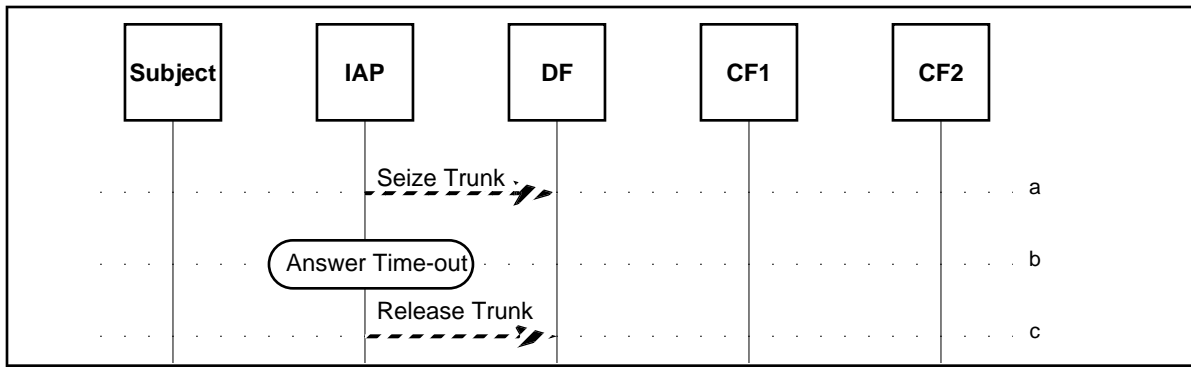

Figure 35: DF Timed Refusal of a CCC Using a Trunk of a Trunk Group

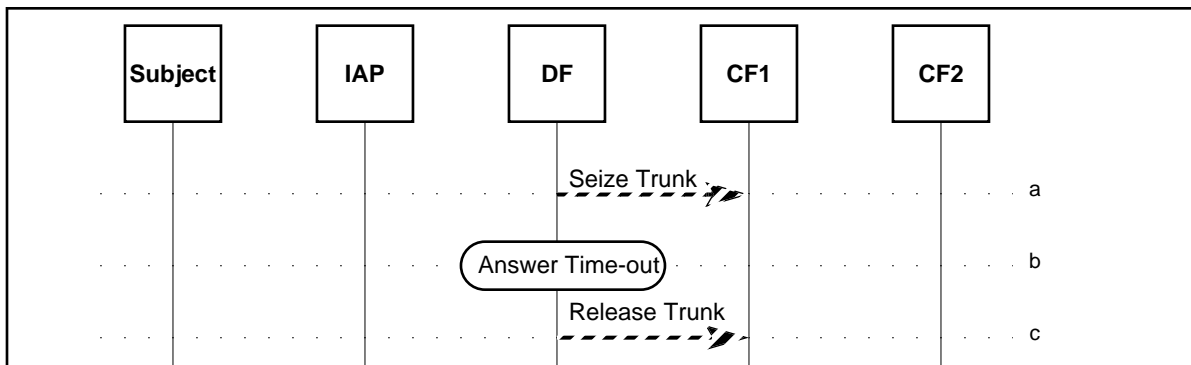

Figure 36: CF Timed Refusal of a CCC Using a Trunk of a Trunk Group

PN-4465-RV1

1
2
3
4
5
6
7
8
9
10
11
12
13
14
15
16
17
18
19
20
21
22
23
24
25
26
27
28
29
30
31
32
33
34
35
36
37
38
39
40
41
42
43
44
45
46
47
48
49
50
51
52
53
54
55
56
57
58
59

A trunk may be refused by some out-of-band signaling sending a release signal (e.g., ISDN or ISUP) as shown in Figure 37 and Figure 38. A refusal by one Collection Function shall not prevent the delivery of call content to another Collection Function that accepts the call content.

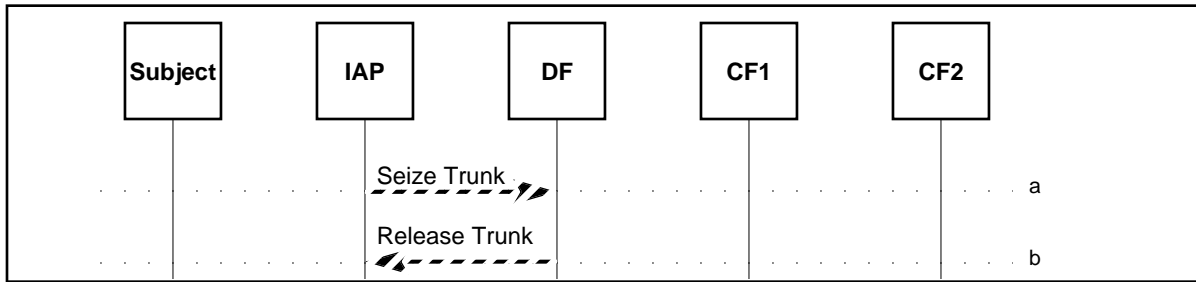

Figure 37: DF Refusal of a CCC Using a Trunk of a Trunk Group

- a. A trunk is seized by the IAP.
- b. The Delivery Function refuses the call by sending a release signal.

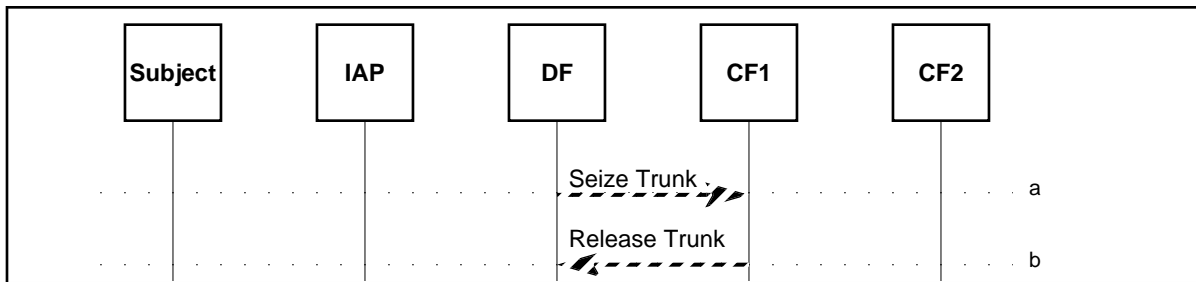

Figure 38: CF Refusal of a CCC Using a Trunk of a Trunk Group

- a. A trunk is seized by the Delivery Function.
- b. The Collection Function refuses the call by sending a release signal.

PN-4465-RV1

B.4.4 CCC Continuity Verification

Immediately upon acceptance of the seizure, the destination may loop around the CCC. The source may apply a test signal (or the call content itself) and verify that the signal returned is the same as the signal that was sent. This continuity test may have to account for various transmission and switching delays. Since a CCC could be looped around and delayed anywhere, this test does not confirm that the call content was actually delivered to its intended destination. CCC continuity verification is shown [Figure 39](#).

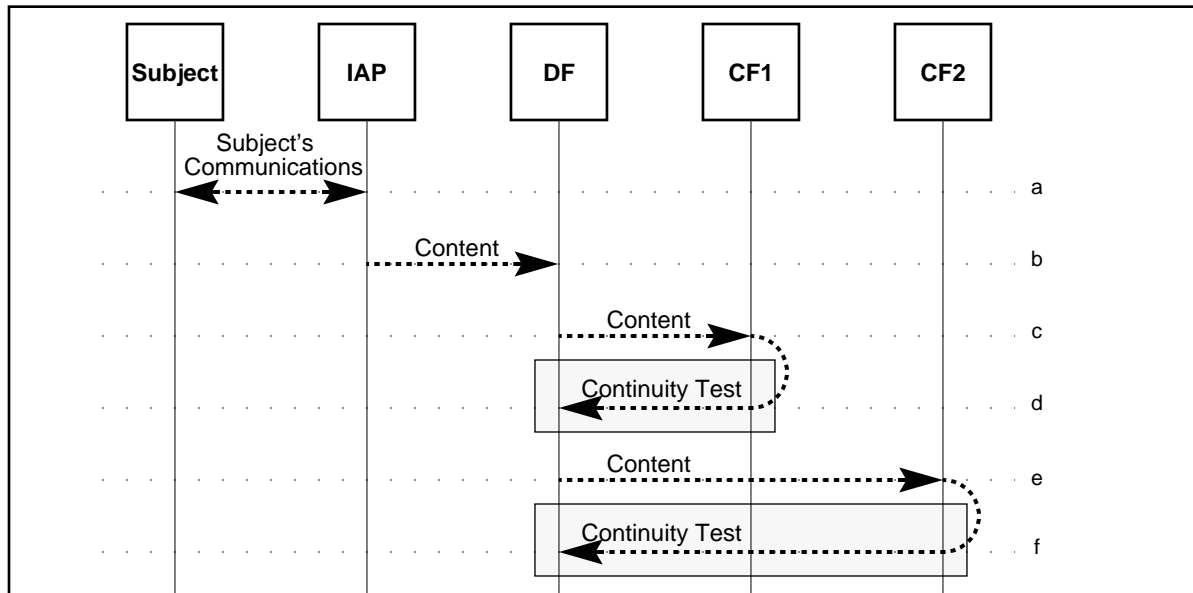

Figure 39: CCC Continuity Test

- c., e. When a CCC is seized; a tone, test pattern, or the call content is applied to the CCC by the source.
- d., f. At the destination of the CCC, the received call content is looped around to the transmit path of the CCC. This loop around should remain in place for the duration of the call content delivery. The destination may detect a preamble tone or test pattern to verify that the CCC is valid from the source. The source shall verify continuity before delivering call content. the source should continuously or periodically verify that the looped around call content is as expected through the duration of call content delivery.

B.4.5 Associate Intercept Subject and Call Identity to the CCC

The CCOpen message associates the intercept subject and a particular call with a particular circuit in a trunk group.

The CCOpen message is communicated in the same manner as dedicated connections (see [B.3.5](#)).

PN-4465-RV1

1
2
3
4
5
6
7
8
9
10
11
12
13
14
15
16
17
18
19
20
21
22
23
24
25
26
27
28
29
30
31
32
33
34
35
36
37
38
39
40
41
42
43
44
45
46
47
48
49
50
51
52
53
54
55
56
57
58
59

B.4.6 Call Content Transfer

The TSP duplicates the intercepted call content and delivers it to the selected Collection Functions over the CCCs identified in the CCOpen message associated with the intercepted communications as shown Figure 40.

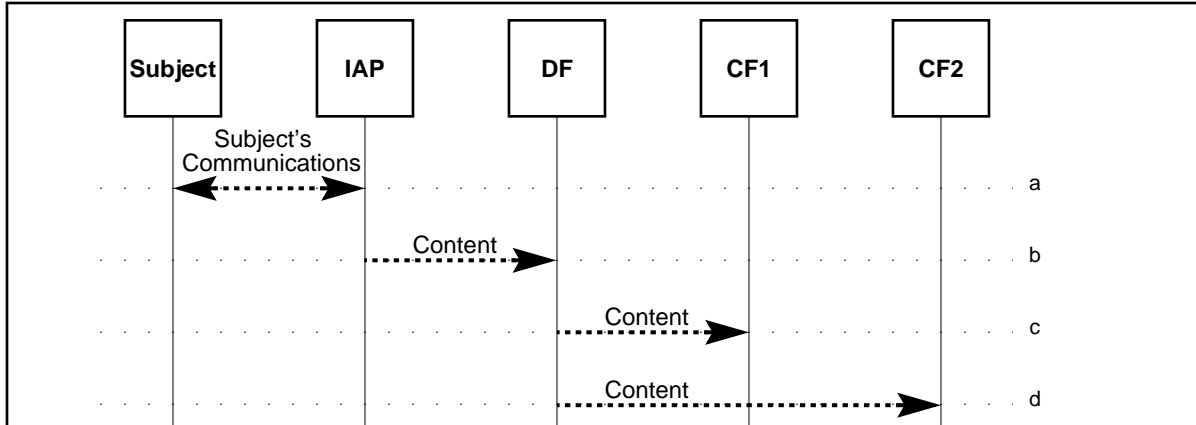

Figure 40: Transfer Call Content Using a Trunk in a Trunk Group

- a. The IAP is enabled and it detects that the intercept subject is communicating.
- b. The intercept subject's communications are intercepted and duplicated, and sent to the Delivery Function.
- c. If authorized, the Delivery Function passes the call content on to the Collection Function.
- d. Optionally, the Delivery Function may duplicate the call content and deliver it to one or more additional authorized Collection Functions.

B.4.7 Early CCC Release by the Destination

A trunk in a trunk group may be released early by the destination with the appropriate trunk release signaling (e.g., on-hook indication with the DS-0 A bits, on-hook on a loop start line, a DISCONNECT message for an ISDN PRI or BRI, a Release for an ISUP trunk) as shown Figure 41. The circuit is free for subsequent intercepts for any intercept subject. Once a CCC is released, the call content delivery may not be re-established.

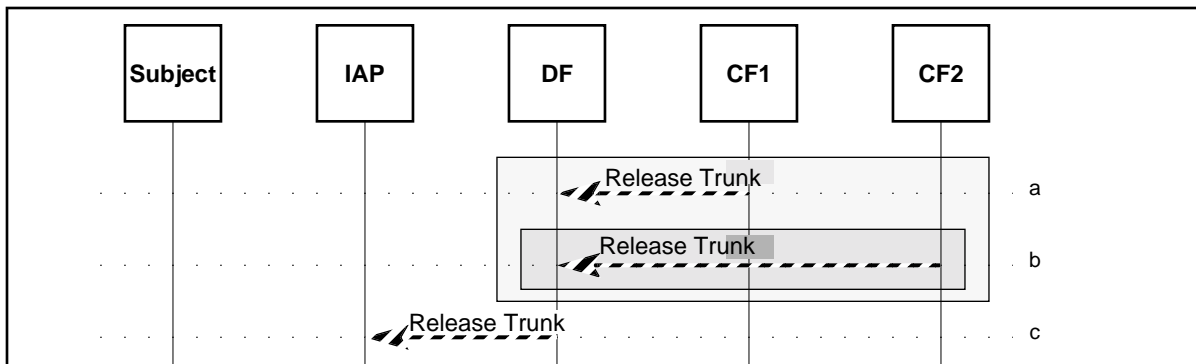

Figure 41: Early Release of CCC Using a Trunk in a Trunk Group

PN-4465-RV1

- a. The Collection Function determines that the call content is not of interest and it signals to release the trunk.
- b. Additionally other Collection Functions may indicate that they are not interested in the call content and they independently signal to release the trunk.
- c. When the Delivery Function determines that the call content is not of interest to any Collection Function, the Delivery Function may send a signal to release the trunk to the IAP.

If the destination is not provisioned for early release, the delivery of call content to the destination may be re-established by the source after an unintended early release.

B.4.8 Disassociate CCC

The CCClose message disassociates the intercept subject and a particular call with a particular trunk in a trunk group.

The CCClose message is used in the same manner as dedicated connections (see B.3.8).

B.4.9 Normal CCC Release by the Source

A trunk in a trunk group is normally released by the source with the appropriate trunk release signaling. (e.g., on-hook indication with the DS-0 A bits, on-hook on a loop start line, a DISCONNECT message for an ISDN PRI or BRI, a Release for an ISUP trunk) as shown in Figure 42. The circuit is free for subsequent intercepts for any intercept subject.

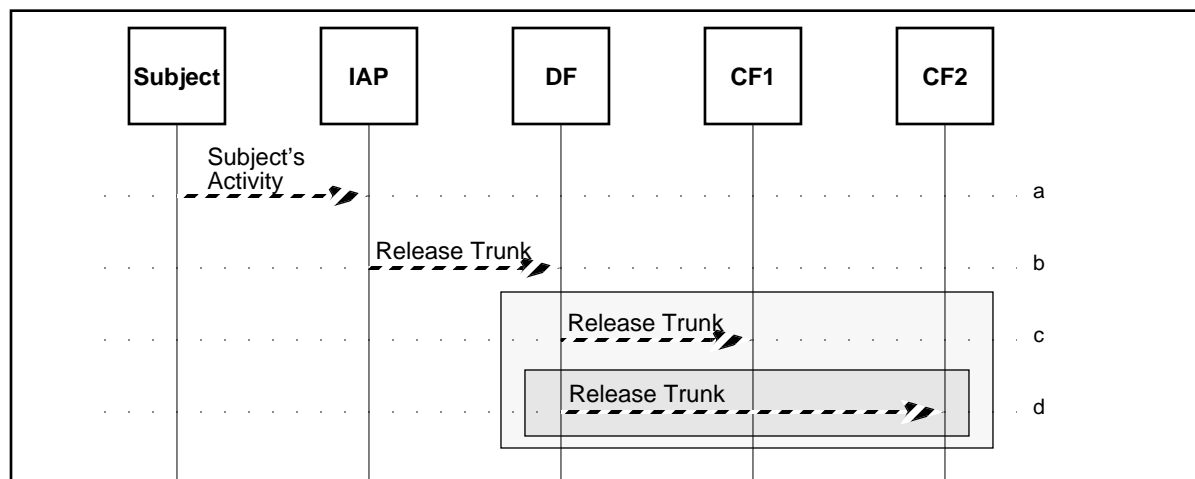

Figure 42: Release CCC Using a Trunk in a Trunk Group

- a. The IAP detects that the intercept subject is no longer communicating.
- b. The IAP sends a signal to release the trunk to the Delivery Function.
- c. The Delivery Function sends a signal to release the trunk to the Collection Function.

PN-4465-RV1

- d. Optionally if authorized, the Delivery Function may send a trunk release signal for each additional seized trunk to one or more Collection Functions.

B.5 Static Directory Number CCC Delivery

Static directory number delivery uses one or more switched connections to convey the call content for a particular intercept subject as shown in Figure 43. Each intercept subject is assigned one or more directory numbers with one number assigned for each CCC that may be delivered. The intercept subject is identified by its association with the directory number. The call content should be separately identified.

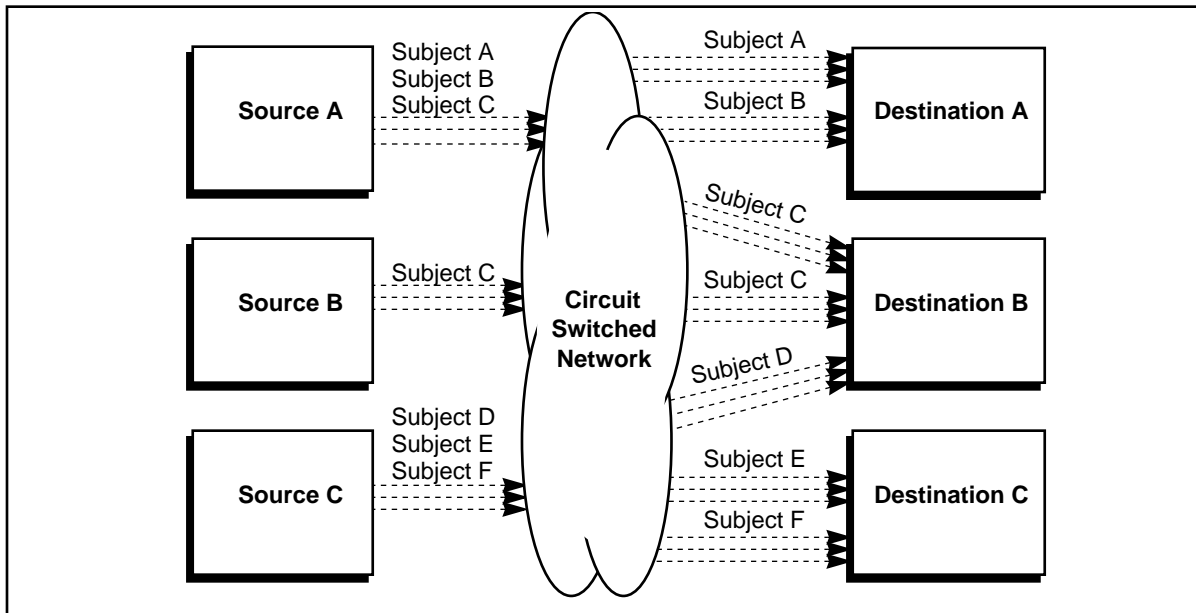

Figure 43: Static Directory Number CCC Delivery

A static directory number uses a circuit from a general set of circuits interfacing a telephone network. These circuits are switched through an intervening network. A given circuit may be used for any appropriate intercept subject. The circuit may be a line or a trunk and the type of circuit may change as the circuit is switched and interworked through the network from the source to the destination.

Only one call may be delivered to a static directory number at a time. No hunt groups may be used. This ensures that the call may be associated by using only the directory number for identification. One directory number should be assigned for the number of calls expected from each enabled IAP or Delivery Function.

Circuits used for static directory numbers are assumed to have the following characteristics:

- a. Seize, setup, answer, disconnect and release signals are available using end-to-end (e.g., DC signaling possibly using the DS-0 A signaling bits and in-band tones, ISUP out-of-band signaling, ISDN PRI out-of-

band signaling, BRI out-of-band signaling, loop start line signaling).
 The particular type of signaling used need not be end-to-end as long as
 it is interworked end-to-end.

- b. There is a one-to-one correspondence between a static directory number, an intercept subject and the CCC.
- c. DTMF C-tone may be used, but it is ignored for the purpose of signaling.
- d. A particular circuit is not dedicated to a particular intercept subject.
- e. An intercept subject may use one or more circuits for delivering its call content. The maximum number of circuits may be specified for a given intercept subject for each destination.
- f. Capacity for the CCCs may be reserved in each functional entity for each intercept subject.
- g. Capacity for the CCCs may or may not be reserved in the network to reduce network blockage.
- h. The number of circuits to each Collection Function need not be equal.

B.5.1 Obtain Network Address of Destination

Select an idle static directory number based on the intercept subject identity and destination. The selection criteria should use all directory numbers on a regular basis.

B.5.2 Setup CCC to Destination

Seize the trunk and setup the call to the destination as shown in [Figure 44](#) using appropriate trunk signaling (e.g., signal off-hook with the DS-0 A bits followed by appropriate MF outpulsing, off-hook on a loop start line followed by appropriate DTMF outpulsing, send a SETUP message with the appropriate called number for an ISDN PRI or BRI, send an Initial Address Message with the appropriate called number for an ISUP trunk).

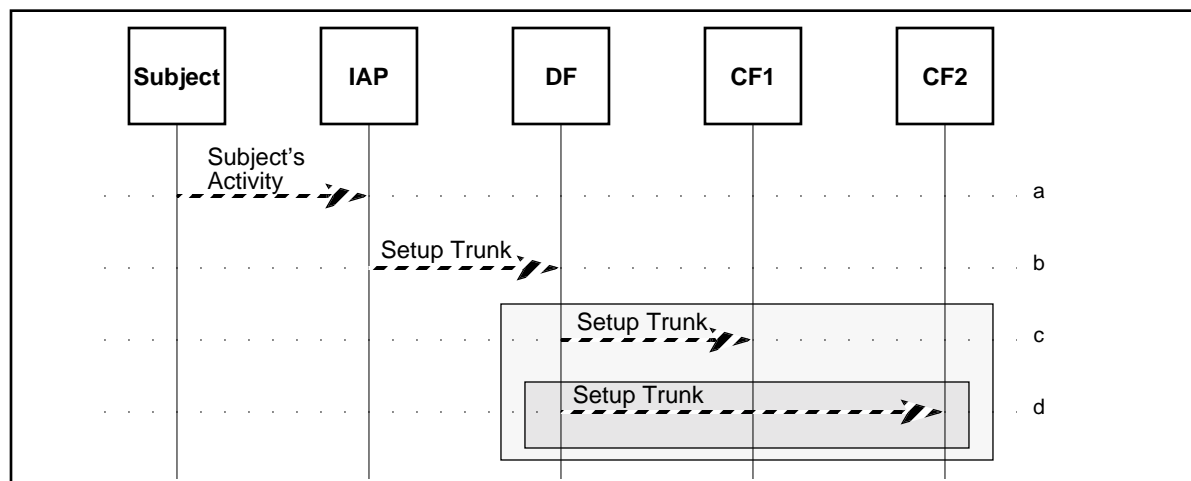

Figure 44: Setup Trunk to Destination

PN-4465-RV1

1 The CCC for a static directory number is established using normal call setup
2 procedures (e.g., loop start line, ISDN, MF trunk or ISUP trunk).

- 3
4 a. IAP is enabled to the Delivery Function.
5 b. IAP sets up a CCC to Delivery Function.
6 c. Delivery Function sets up a CCC to an authorized Collection Function.
7 d. Additionally the Delivery Function may setup CCCs to other autho-
8 rized Collection Functions.
9
10

11 **B.5.3 Destination Acceptance or Refusal of a CCC**

12
13
14 The CCC is accepted by answering the delivered call. The CCC may be
15 refused by not answering the delivered call within a period of time (mutually
16 agreed upon between the TSP and LEA) or by refusing the connection
17 directly.
18

19
20 The acceptance or refusal is communicated in the same manner as trunked
21 connections (see B.4.3).
22

23 **B.5.4 CCC Continuity Verification**

24
25
26 Circuit continuity should be verified upon call setup since the connection
27 between the source and the destination is unknown without this test.
28

29
30 CCC continuity verification is done in the same manner as trunked connec-
31 tions (see B.4.4).
32

33 **B.5.5 Associate Intercept Subject and Call Identity to the CCC**

34
35 The intercept subject is associated with a static directory number for the life
36 of the intercept. The CCOpen message associates a particular call with the
37 static directory number.
38

39
40 The CCOpen message is communicated in the same manner as dedicated
41 connections (see B.3.5).
42

43 **B.5.6 Call Content Transfer**

44
45 The TSP duplicates the intercepted call content and delivers it to the selected
46 Collection Functions over the CCCs identified in the CCOpen message
47 associated with the intercepted communications as shown Figure 40 (see
48 B.4.6).
49

50 **B.5.7 Early CCC Release by the Destination.**

51
52
53 CCCs may be released early by the destination in the same manner as trunked
54 connections (see B.4.7).
55

56
57 Releasing the CCC frees the static directory number for subsequent inter-
58 cepts.
59

If the destination is not provisioned for early release, the delivery of call content to the destination may be re-established by the source after an unintended early release.

B.5.8 Disassociate CCC

The CCClose message disassociates the intercept subject and a particular call with the static directory number.

The CCClose message is used in the same manner as dedicated connections (see B.3.8).

B.5.9 Normal CCC Release by the Source

CCCs are released normally by the source in the same manner as trunked connections (see B.4.9).

Releasing the CCC frees the static directory number for subsequent intercepts.

B.6 Packet Data CCC Delivery

The text in this section may not apply to an IP network.

Packet data delivery uses one or more packet-switched connections to convey the call content for a particular intercept subject as shown in Figure 45. Either connection-oriented or connectionless packet data services may be used. Each intercept subject is assigned one or more data network addresses with one number assigned for each CCC that may be delivered. The intercept subject is identified by its association with the data network address. The call content is separately identified with the PDU Type parameter of the CCOpen message.

Only one communication may be delivered to a given data network address at a time. A unique address shall be used. This ensures that the communication may be associated by using only the data network address for identification. One data network address should be assigned for each of the number of communications expected from each enabled IAP or Delivery Function.

Channels used for packet data CCC delivery are assumed to have the following characteristics:

- a. The relationship between the intercept subject, a particular IAP and the CCC is uniquely identified by the data network address.
- b. A particular physical channel may be shared by several intercept subjects.
- c. One or more channels may deliver the call content of any particular intercept subject. The maximum number of channels may be specified for a given intercept subject for each IAP and destination.

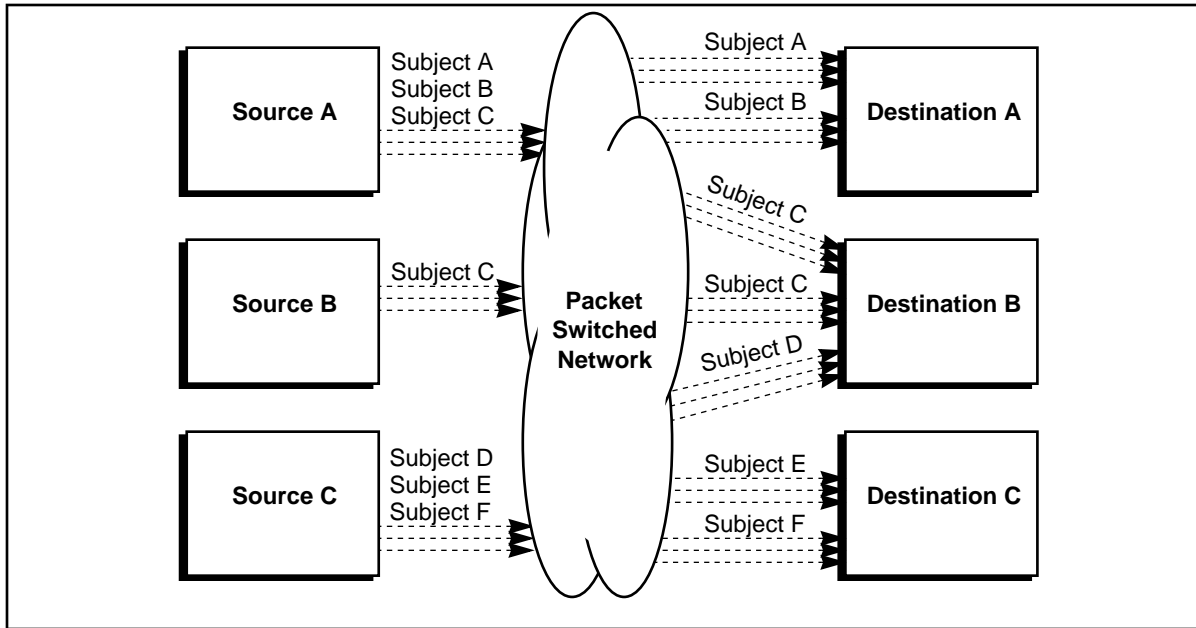

Figure 45: Packet Data CCC Delivery

- d. Capacity for the CCCs may be reserved in each functional entity for each intercept subject.
- e. Capacity for the CCCs may or may not be reserved in the network to reduce network blockage.
- f. The number of channels to each Collection Function need not be equal.

B.6.1 Obtain Network Address of Destination

Select a data network address based on the intercept subject identity and destination.

B.6.2 Setup CCC to Destination

If necessary, setup a connection-oriented data call to the destination (e.g., an X.25 SETUP).

B.6.3 Destination Acceptance or Refusal of a CCC

The CCC is accepted by answering the delivered connection-oriented data call. The CCC may be refused by not answering the delivered call within a period of time (mutually agreed upon between the TSP and LEA) or by refusing the connection directly.

Connectionless CCC delivery channels cannot be refused.

B.6.4 CCC Continuity Verification

Data circuit continuity may be verified using normal link or end-to-end acknowledgments appropriate to the selected packet data service.

B.6.5 Associate Intercept Subject and Call Identity to the CCC

The intercept subject is associated with a network data address for the life of the intercept. The CCOpen message associates a particular call with the data network address in the same manner as dedicated connections.

The CCOpen message is communicated in the same manner as dedicated connections (see B.3.5).

B.6.6 Call Content Transfer

Call content is transferred using the data transfer appropriate to the selected packet data service.

B.6.7 Early CCC Release by the Destination

Connection-oriented CCCs may be released early by the destination.

Releasing the CCC frees the data network address for subsequent intercepts.

Connectionless CCCs are not released.

If the destination is not provisioned for early release, the delivery of call content to the destination may be re-established by the source after an unintended early release.

B.6.8 Disassociate CCC

The CCCclose message disassociates the intercept subject and a particular call with the data network address.

The CCCclose message is used in the same manner as dedicated connections (see B.3.8).

B.6.9 Normal CCC Release by the Source

A connection-oriented channel is released normally by the source.

Connectionless CCCs are not released.

Releasing the CCC frees the data network address for subsequent intercepts.

B.7 Delivery Bearer Service

Circuit-mode call content may be delivered with analog or digital circuits (DS-0 or ISDN B-channels) when voice (speech) or audio bearer services are delivered. Circuit-mode digital data bearer services require digital circuits.

Packet-mode communications may be delivered using circuit-mode CCCs, packet-mode CCCs, or a CDC (for certain packets).

B.8 Separated Content Delivery

The transmit and receive paths of the call content are kept separated. This type of delivery is appropriate for digital bearer services and some voice (speech) or audio services that take advantage of end-to-end separated communications. It may also be used to avoid the introduction of distortion in the delivery of the call content.

Call-identifying information is delivered over a separate data channel as shown in Figure 46.

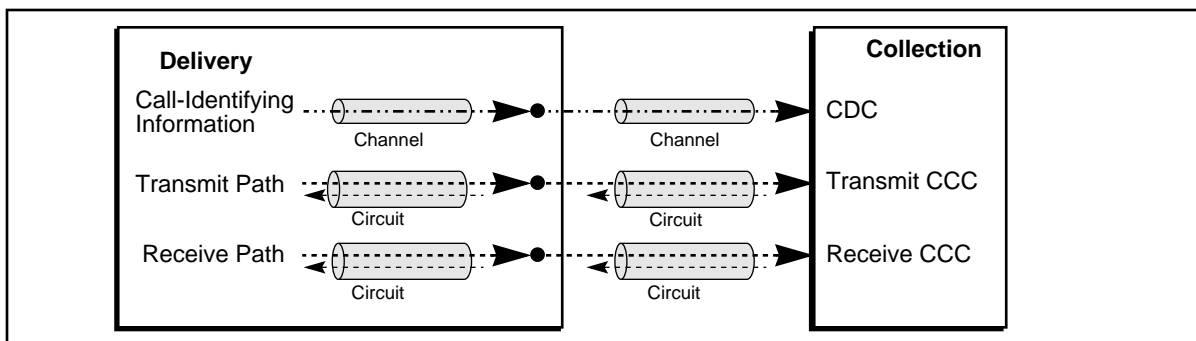

Figure 46: Separated Content Delivery

B.9 Combined Content Delivery

The transmit and receive paths of the call content is combined and delivered over a single circuit for the communications of an intercept subject. This type of delivery is appropriate for voice (speech) and audio bearer service communications, especially when one of the parties is on a two-wire loop start line. Since the bridging device may cause signal distortion, this type of delivery may not be appropriate for digital bearer services.

Call-identifying information is delivered over a separate data channel as shown in Figure 47.

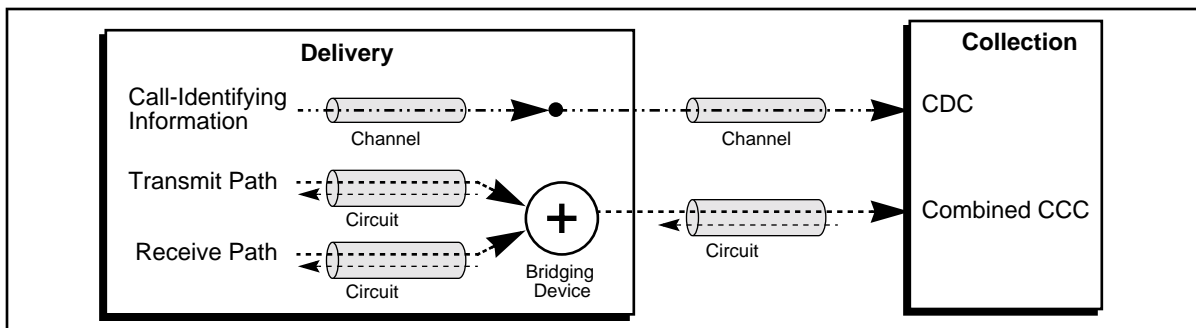

Figure 47: Combined Content Delivery

PN-4465-RV1

B.10 Signaling for Switched Delivery

Switched circuits may use any signaling method including the following:

- MF signaling (to access switching networks or to convey the directory number to the Collection Function upon network egress);
- ISUP signaling;
- ISDN signaling; or
- metallic signaling methods (e.g., analog facility signaling).

B.11 Call Content Delivery Delay

Call content may be delayed in some situations so that a channel can be setup and switched through a network and not lose any important call content (i.e., any call content after answer and before release).

The strategies for managing switched circuits is beyond the scope of this Interim Standard. It is the responsibility of the Access or Delivery Function to ensure that a CCC is available or connected to the downstream Delivery or Collection Function for the timely delivery of the call content. Such strategies may include, but not be limited to, the following (in no particular order):

- delayed or
- anticipatory.

Delayed sets up a CCC delivery circuit connection to the downstream function upon demand. The call content is delayed by any time difference in the availability of call content and the acceptance by the downstream function(s).

Anticipatory sets up a circuit connection to the downstream function in anticipation of call content availability. Call content should not be lost or delayed. One or more circuits are set up when the intercept is provisioned. As circuits are used, additional circuit connections may be set up in anticipation of additional demand. The additional circuit connections may be dropped as the additional demand ceases.

PN-4465-RV1

B.12 Call Content Distribution

Call content may be distributed to more than one Collection Function as shown in Figure 48. The call content must be screened to ensure that only authorized content is delivered. The characteristics of each delivery may be different for each destination Collection Function.

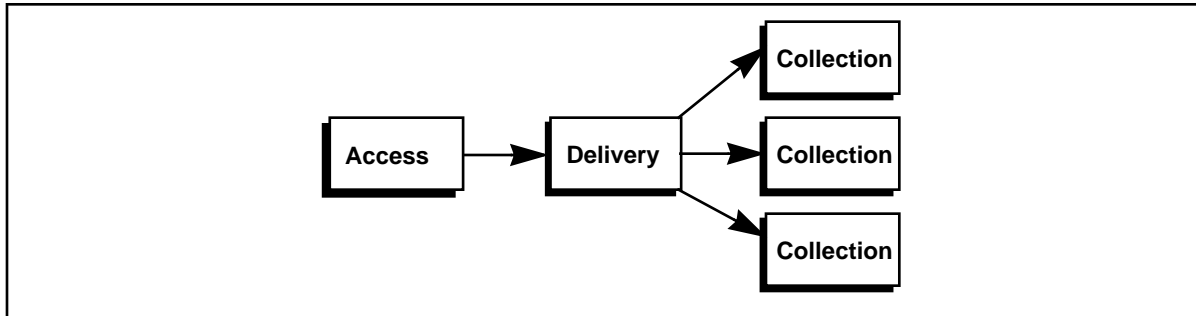

Figure 48: Call Content Distribution

Call content may be delivered through an intervening Delivery Function, called a Pivoted Delivery Function, to allow a TSP to centralize its screening and distribution of intercepted information as shown in Figure 49.

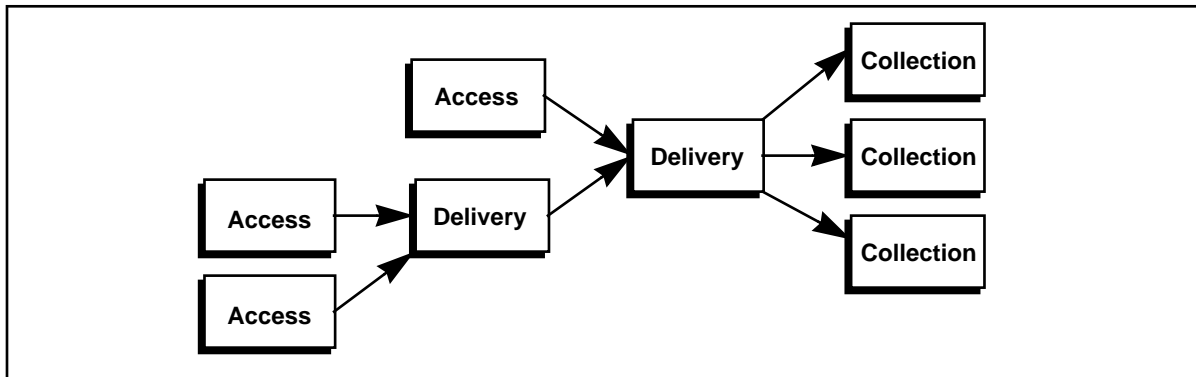

Figure 49: Pivoted Delivery with Distribution

B.13 DTMF C-Tone Signaling Procedures

Some call events described in Stage 1 and Stage 2 can be signaled using tones. This method has been used for electronic surveillance circuits for years.

Tone signaling allows Plain Old Telephone Service (POTS) switchhook signaling of the intercepted communication to be sent over a CCC and yet allow the CCC to use its Direct Current (DC) loop signaling to communicate its switchhook signaling. While the intercept subject's telephone instrument is on-hook, a DTMF C-tone is sent. This allows for simple signaling for origination attempts, call controls (DTMF or decadic bursts for digits and switchhook flashes), answer, disconnect and release. The signals are differentiated by timing in the same manner as traditional DC signaling, that is:

- a. C-tone off is off-hook or a seizure.

- b. 10 ms C-tone on followed by 10 ms C-tone off ($\pm 10\%$) is a decadic dial pulse.
- c. 100 ms C-tone off separates the individual decadic digits. A digit consists of 1 to 10 pulses (with 10 pulses representing the digit 0).
- d. DTMF digits (0-9, * and #) are sent normally.
- e. 200 to 1500 ms C-tone on followed by C-tone off is a switchhook flash.
- f. 2000 ms C-tone on is a disconnect or on-hook.

Figure 50 shows the frequency pairs used for each DTMF digit.

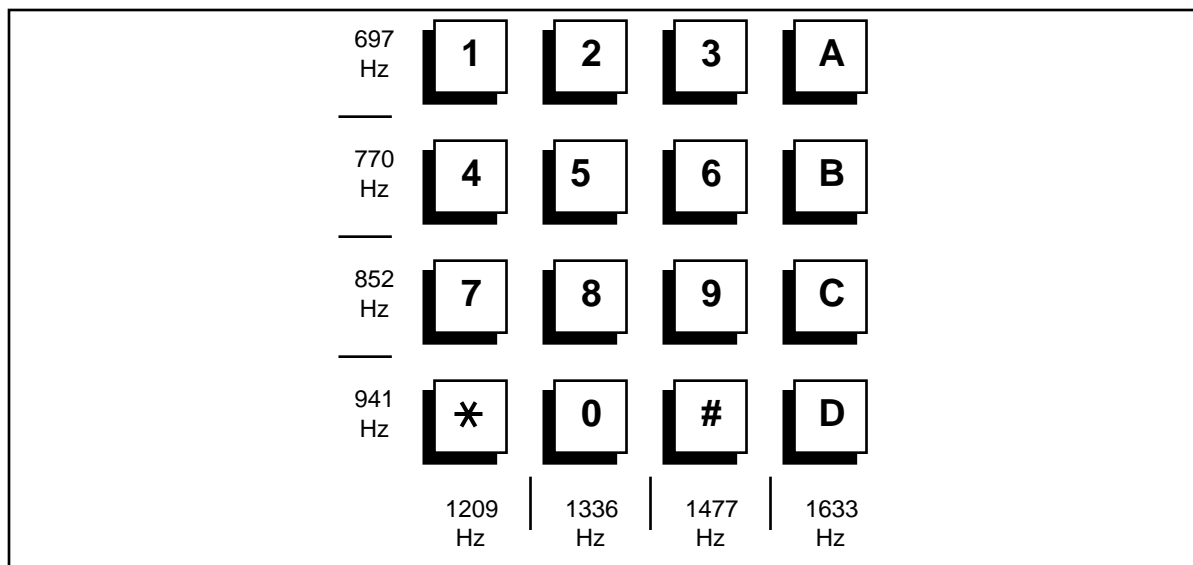

Figure 50: Digit to DTMF Tone Mapping

Figure 51 shows an example of normal DC and DTMF signaling converted to DTMF C-tone signaling.

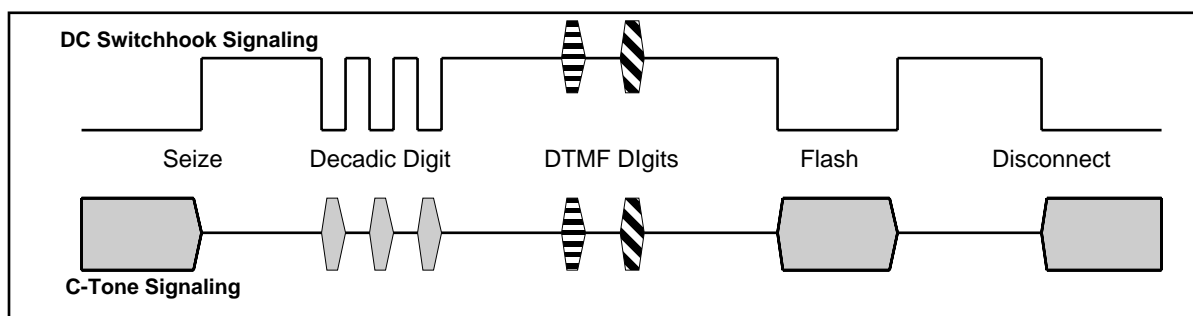

Figure 51: DTMF C-tone Signaling

Out-of-band signaling conveys additional information and is used for modern telephone services, such as ISDN and wireless.

PN-4465-RV1

1
2
3
4
5
6
7
8
9
10
11
12
13
14
15
16
17
18
19
20
21
22
23
24
25
26
27
28
29
30
31
32
33
34
35
36
37
38
39
40
41
42
43
44
45
46
47
48
49
50
51
52
53
54
55
56
57
58
59

Annex C CDC Delivery Methods

This Annex is informative and is not considered part of this Interim Standard.

This Annex describes the CDC delivery services as a set of mechanisms, characteristics, and options that may be considered when selecting a delivery method.

CDCs may be delivered using one of the following delivery methods:

- a. Dedicated data circuit, or
- b. Dedicated data link.

Normally call-identifying information is sent as the events occur. Call-identifying information may be delayed to be synchronized with delayed call content.

C.1 Dedicated Data Circuit CDC Delivery

Call data is delivered over a data circuit that is dedicated to a particular intercept subject as shown in Figure 52.

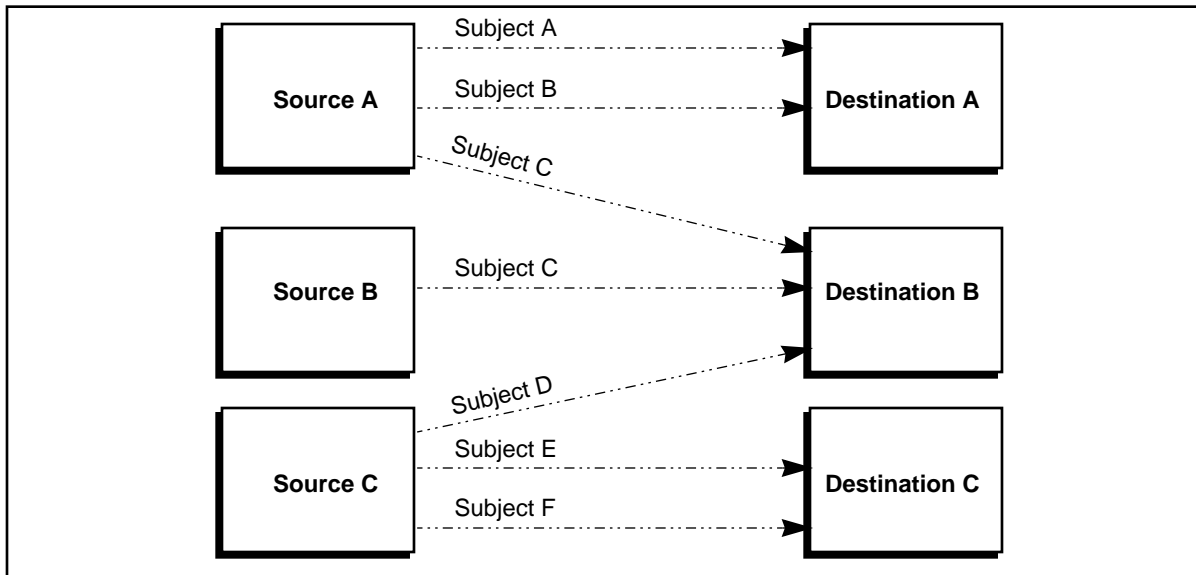

Figure 52: Dedicated Data Circuit CDC Delivery

PN-4465-RV1

C.2 Dedicated Data Link CDC Delivery

Call data is delivered over a data circuit that is dedicated to a particular destination, but is shared with the intercept subjects monitored by the destination as shown in Figure 53.

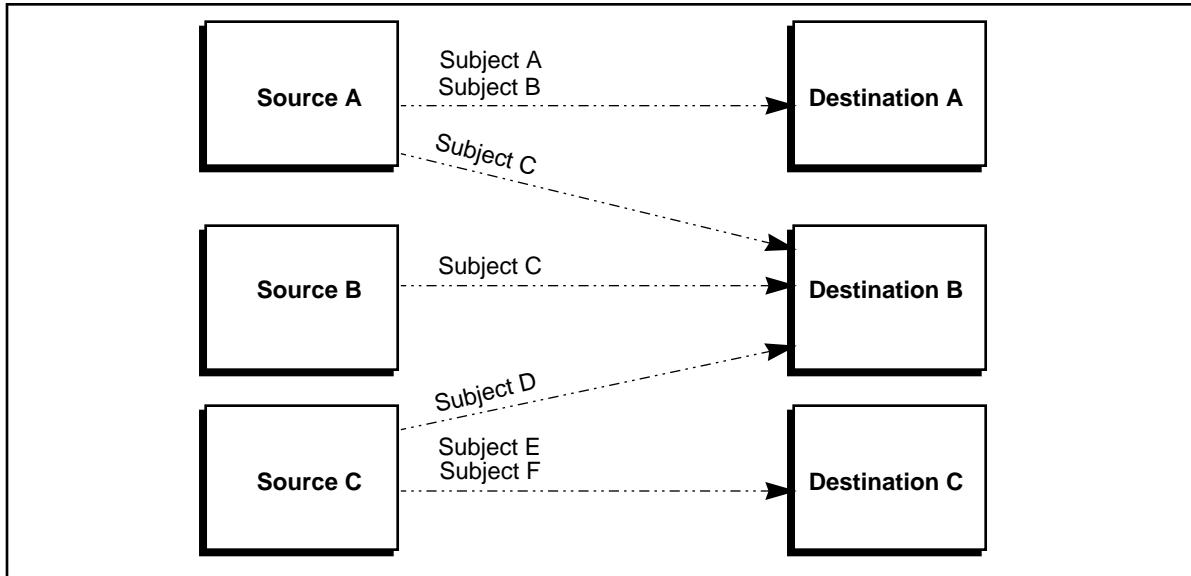

Figure 53: Dedicated Data Link CDC Delivery

C.3 Call Data Distribution

Call data may be distributed to more than one Collection Function. The information delivered to each Collection Function must be duplicated and screened to ensure that only authorized information is delivered.

The delivery options may be different for each path between a Delivery and a Collection Function.

PN-4465-RV1

1
2
3
4
5
6
7
8
9
10
11
12
13
14
15
16
17
18
19
20
21
22
23
24
25
26
27
28
29
30
31
32
33
34
35
36
37
38
39
40
41
42
43
44
45
46
47
48
49
50
51
52
53
54
55
56
57
58
59

Annex D Information Access Scenarios

This Annex is informative and is not considered part of this Interim Standard.

Several basic circuit-mode call scenarios are described in this section. The intent of this section is to provide representative examples of reported events over a CDC and changes in connections for the CCC. This section is not an exhaustive set of examples. Each specific scenario applies to a particular service and configuration, but should be considered to be applicable to other similar services and configurations. TSPs may provide access using configurations and accesses not shown and systems are not obligated to implement particular services or accesses in the way illustrated. There may also be implementation differences providing different numbers of [CallIdentity](#) per scenarios. (The scenarios assume that there is one [CallIdentity](#) used for each CCC, unless noted otherwise.)

The *Step* column provides a reference number for a scenario step.

The *Action* column describes a particular action by the intercept subject or by another party.

The *Reported Event* column describes the event messages sent over the CDC. The Interface Access Point (IAP) is depicted as “XXXIAP>.” Following the IAP is the party/channel involved in the event and then the event.

These scenarios show the [CCOpen](#) occurring at the earliest opportunity. The [CCOpen](#) is required before the call is answered. The [CCOpen](#) and [CCClose](#) may not occur at all in scenarios where the call is not answered. The [CCOpen](#) may be delayed until answer, such as step 5 in [D.4](#) and step 3 in [D.6](#).

In scenarios involving multiple systems, the IAPs for a system are subscripted to indicate a particular system. If all of the indicated intercepts are not activated, some information loss is possible. If all of the indicated intercepts are activated, some information may be duplicated.

The *Connection Diagram* column depicts the connections at the end of a particular action.

[Figure 54](#) depicts the connection diagram convention used in this Interim Standard to describe a switch connection for a single intercept call of a switching system.

The switch symbol represents a system which has been presented with the electronic surveillance court order.

The switch control symbol represents that part of the system that detects and processes any applicable signaling information.

The CCCs may use any content delivery service using one or more circuits (see [Annex B](#)).

PN-4465-RV1

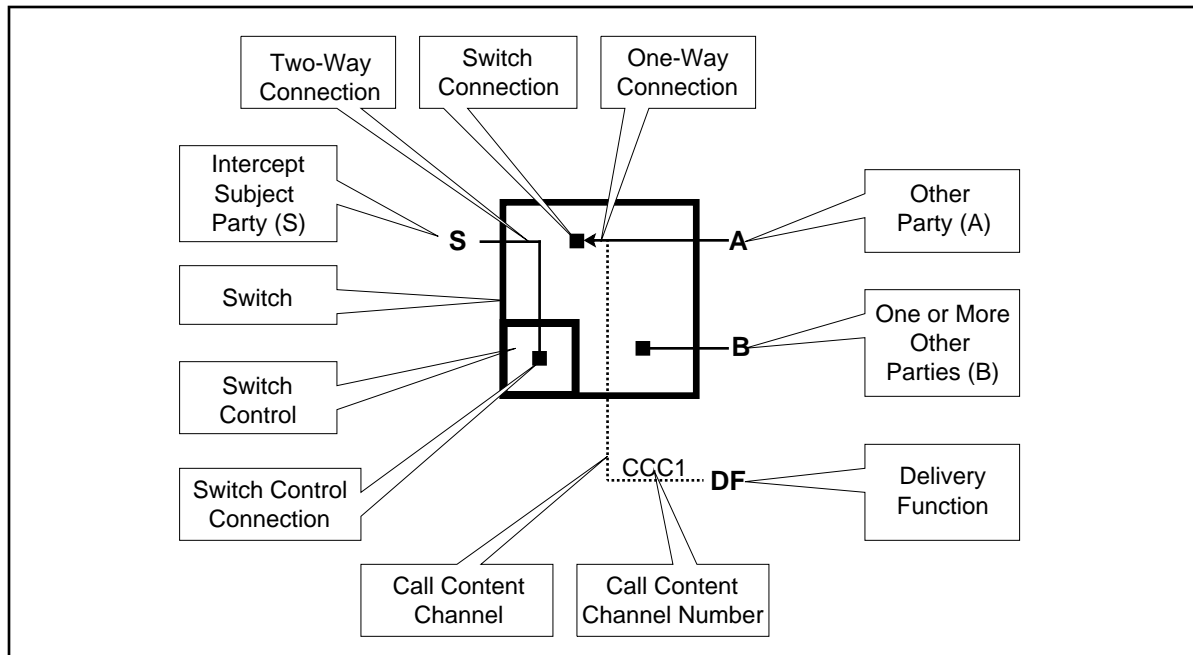

Figure 54: Switch Connection Diagram Conventions

Call and telecommunication services are built from one or more of the following simple switch connections as shown in Table 18. Actual accesses may be accomplished with one or more of these simple switch connections.

Table 18: Simple Switch Connections (Sheet 1 of 3)

Switch Connection Name	Switch Connection Description	Diagram
Idle	The call connections for the IAP are idle.	
Intercept Subject Suspended	The intercept subject is suspended. No other party is connected. Announcements or tones may be applied toward the intercept subject.	
Intercept Subject Collect	The switch control is collecting digits from the intercept subject. No other party is connected to the intercept subject. Announcements or tones may be applied toward the intercept subject. The call content connection may be logical, rather than physical, provided that the information characterizes the system prompts to the subject and the responses from the subject.	
Intercept Subject Awaiting Answer	The intercept subject is waiting for the other party (A) to answer. The intercept subject may be able to hear call progress tones from the partially cut-through circuit.	

PN-4465-RV1

1
2
3
4
5
6
7
8
9
10
11
12
13
14
15
16
17
18
19
20
21
22
23
24
25
26
27
28
29
30
31
32
33
34
35
36
37
38
39
40
41
42
43
44
45
46
47
48
49
50
51
52
53
54
55
56
57
58
59

Table 18: Simple Switch Connections (Sheet 2 of 3)

Switch Connection Name	Switch Connection Description	Diagram
Intercept Subject Connected	The intercept subject is connected and fully cut-through to the other party (A) (at least from the switch perspective). If the intercept subject was previously cut-through, this may also be used to indicate a change in parties (i.e., a new party added, an existing party dropped, an existing party split off).	
Other Partial Cut-through	The other party (A) is partially cut-through to allow it to monitor call progress announcements or tones. The intercept subject may be alerting for party (A).	
Other Collect	The other party (A) is fully cut-through to allow it to monitor announcements and tones. Call control monitors in-band signaling tones from the other party (A).	
Other Suspended	The other party (A) is fully cut-through to allow it to monitor announcements or tones.	
Other Held	The other party (A) is placed on hold, but is not monitored.	
Redirection Alerting	A call between a party (A) and the intercept subject is redirected to one or more other parties (B). The call is only partially cut-through to allow party (A) to monitor call progress tones. One or more other parties (B) may be alerting, but none has answered.	
Redirection Await Answer	A call between a party (A) and the intercept subject is answered and redirected to one or more other parties (B). The call is only partially cut-through to the other parties (B) to allow party (A) to monitor call progress tones. One or more other parties (B) may be alerting, but none has answered. Monitored on the A leg, the call has been answered and cut-through.	
Redirection Connected	A call between a party (A) and the intercept subject is redirected to one or more parties (B). The call is fully cut-through to allow party (A) and the other parties (B) to communicate.	

PN-4465-RV1

1
2
3
4
5
6
7
8
9
10
11
12
13
14
15
16
17
18
19
20
21
22
23
24
25
26
27
28
29
30
31
32
33
34
35
36
37
38
39
40
41
42
43
44
45
46
47
48
49
50
51
52
53
54
55
56
57
58
59

Table 18: Simple Switch Connections

(Sheet 3 of 3)

Switch Connection Name	Switch Connection Description	Diagram
Multi-Party Awaiting Answer	The intercept subject is attempting a call to party A and one or more other parties (B). The paths are only partially cut-through to allow the intercept subject to monitor call progress announcement and tones. Only the intercept subject leg is monitored.	
Multi-Party Connected and Awaiting Answer	The intercept subject has cut-through a call to party (A) and is attempting a call to one or more parties (B). The paths to the other parties (B) is only partially cut-through to allow the intercept subject to monitor call progress announcement and tones. Only the intercept subject leg is monitored.	
Multi-Party Connected	The intercept subject has cut-through a call to party (A) and one or more other parties (B). Only the intercept subject leg is monitored. The intercept subject with an existing multi-party connection has a change in parties (i.e., one or more parties joining, one or more parties dropped, one or more parties split off).	



1
2
3
4
5
6
7
8
9
10
11
12
13
14
15
16
17
18
19
20
21
22
23
24
25
26
27
28
29
30
31
32
33
34
35
36
37
38
39
40
41
42
43
44
45
46
47
48
49
50
51
52
53
54
55
56
57
58
59

PN-4465-RV1

D.1 Simple Abandoned Call Attempt

An intercept subject at (202) 555-0000 goes off-hook. Without dialing any digits, the intercept subject goes back on-hook.

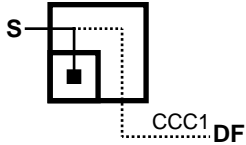
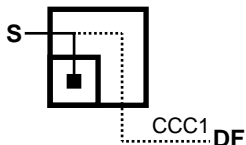

Table 19: Simple Abandoned Call Attempt Scenario

Step	Action	Reported Event	Connection Diagram
1	An intercept subject at (202) 555-0000 goes off-hook.	CIAP> CCOpen (CCC1)	
2	Without dialing any digits, the intercept subject goes back on-hook.	IDIAP> Origination (User Input = "") IDIAP> Release CIAP> CCClose (CCC1)	

D.2 Partial Dial Abandon

An intercept subject at (202) 555-0000 goes off-hook and dials a few digits (123). The intercept subject goes back on-hook.

Table 20: Partial Dial Abandon Scenario

Step	Action	Reported Event	Connection Diagram
1	An intercept subject at (202) 555-0000 goes off-hook and dials a few digits (123).	CIAP> CCOpen (CCC1)	
2	The intercept subject goes back on-hook.	IDIAP> Origination (User Input = "123") IDIAP> Release CIAP> CCClose (CCC1)	

PN-4465-RV1

1
2
3
4
5
6
7
8
9
10
11
12
13
14
15
16
17
18
19
20
21
22
23
24
25
26
27
28
29
30
31
32
33
34
35
36
37
38
39
40
41
42
43
44
45
46
47
48
49
50
51
52
53
54
55
56
57
58
59

D.3 Pre-Answer Abandon

An intercept subject at (202) 555-0000 goes off-hook and dials Party A at (202) 555-1111. The call is extended to Party A. The intercept subject goes back on-hook before the call is answered.

Table 21: Pre-Answer Abandon Scenario

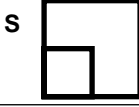
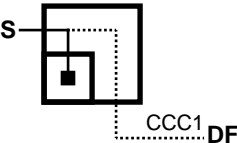
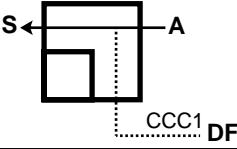
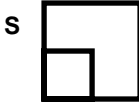
Step	Action	Reported Event	Connection Diagram
1	The call connections for the IAP are idle.		
2	The intercept subject at (202) 555-0000 goes off-hook to initiate a call.	CIAP> CCOpen (CCC1)	
3	The intercept subject dials Party A at (202) 555-1111.		No change.
4	The call is extended to Party A.	IDIAP> Origination (User Input="2025551111", Called Party=2025551111)	
5	The intercept subject abandons the call.	IDIAP> Release CIAP> CCClose (CCC1)	

PN-4465-RV1

1
2
3
4
5
6
7
8
9
10
11
12
13
14
15
16
17
18
19
20
21
22
23
24
25
26
27
28
29
30
31
32
33
34
35
36
37
38
39
40
41
42
43
44
45
46
47
48
49
50
51
52
53
54
55
56
57
58
59

D.4 Simple Outgoing Call

The intercept subject (S) at (202) 555-0000 goes off-hook to initiate a call and dials Party A at (202) 555-1111. After the call is completed, the intercept subject dials more digits. Later the intercept subject disconnects to release the call.

Table 22: Simple Outgoing Call Scenario

Step	Action	Reported Event	Connection Diagram
1	The call connections for the IAP are idle.		
2	The intercept subject at (202) 555-0000 goes off-hook to initiate a call.	CIAP> CCOpen (CCC1)	
3	The intercept subject dials Party A at (202) 555-1111.		No change.
4	The call is extended to Party A.	IDIAP> Origination (User Input="2025551111", Called Party=2025551111)	
5	Party A answers.	IDIAP> Answer ()	
6	The intercept subject dials more digits, 1234567.		No change.
7	The intercept subject releases.	IDIAP> Release CIAP> CCClose (CCC1)	

For system using *en bloc* sending (such as ISDN or wireless), steps 2, 3, and 4 may be combined into a single step.

Table 23: Alternate Steps for *en bloc* Sending

Step	Action	Reported Event	Connection Diagram
2 3 4	The intercept subject at (202) 555-0000 initiates a call to Party A at (202) 555-1111 using <i>en bloc</i> sending.	CIAP> CCOpen (CCC1) IDIAP> Origination (User Input="2025551111", Called Party=2025551111)	

PN-4465-RV1

D.5 Re-Origination

The intercept subject (S) at (202) 555-0000 goes off-hook to initiate a call and dials Party A at (202) 555-1111. After the call is completed, Party A hangs up. The intercept subject re-originate a call to Party B at (202) 555-2222. Later the intercept subject disconnects to release the call.

Table 24: Re-origination Call Scenario

Step	Action	Reported Event	Connection Diagram
1	The call connections for the IAP are idle.		
2	The intercept subject at (202) 555-0000 goes off-hook to initiate a call.	CIAP> CCOpen (CCC1)	
3	The intercept subject dials Party A at (202) 555-1111.		No change.
4	The call is extended to Party A.	IDIAP> Origination (User Input="2025551111", Called Party=2025551111)	
5	Party A answers.	IDIAP> Answer ()	
6	Party A disconnects.	IDIAP> Release CIAP> CCClose (CCC1)	
7	The intercept subject initiates another call with re-origination to Party B at (202) 555-2222.	CIAP> CCOpen (CCC1)	
8	The call is extended to Party B.	IDIAP> Origination (User Input="2025552222", Called Party=2025552222)	
9	Party B answers.	IDIAP> Answer ()	
10	The intercept subject releases.	IDIAP> Release CIAP> CCClose (CCC1)	

PN-4465-RV1

1
2
3
4
5
6
7
8
9
10
11
12
13
14
15
16
17
18
19
20
21
22
23
24
25
26
27
28
29
30
31
32
33
34
35
36
37
38
39
40
41
42
43
44
45
46
47
48
49
50
51
52
53
54
55
56
57
58
59

Alternatively steps 6 and 7 may be as follows for some switching systems:

Table 25: Alternate Re-origination Call Scenario Steps

Step	Action	Reported Event	Connection Diagram
6	Party A disconnects.	IDIAP> Release	
7	The intercept subject initiates another call with re-origination.		

D.6 Simple Incoming Call

The intercept subject (S) at (202) 555-0000 receives a voice call from Party A at (202) 555-1111. The intercept subject answers the call. The call is released.

Table 26: Simple Incoming Call Scenario

Step	Action	Reported Event	Connection Diagram
1	The call connections for the IAP are idle.		
2	The intercept subject at (202) 555-0000 receives a voice call from Party A at (202) 555-1111.	IDIAP> TerminationAttempt (2025551111) CIAP> CCOpen (CCC1)	
3	The intercept subject answers the call.	IDIAP> Answer (2025550000)	
4	The call is released.	IDIAP> Release CIAP> CCClose (CCC1)	

PN-4465-RV1

D.7 Call Waiting and Recall

The intercept subject (S) at (202) 555-0000 receives a voice call from Party A at (202) 555-1111. The intercept subject answers the call. Later, a second call arrives to alert the intercept subject from Party B at (202) 555-2222. The intercept subject answers the second call with Call Waiting. The intercept subject toggles back to the original call. The intercept subject ends that call by hanging up causing the held party to recall the intercept subject. The intercept subject answers the call. The second call is released.

This sequence is shown with three separate scenarios to show some variations of managing the **CallIdentity** parameter. It is shown with a single **CallIdentity** for the entire multiparty call, with a separate **CallIdentity** for each leg of a call merged into one **CallIdentity**, and with a **CallIdentity** for separate calls. The value of the **CallIdentity** is shown within square brackets, e.g., [1]. Separate calls are separated by commas, e.g., [1,2], and a call with multiple identities is shown with dots joining the constituent identities, e.g., [1•2].

PN-4465-RV1

1
2
3
4
5
6
7
8
9
10
11
12
13
14
15
16
17
18
19
20
21
22
23
24
25
26
27
28
29
30
31
32
33
34
35
36
37
38
39
40
41
42
43
44
45
46
47
48
49
50
51
52
53
54
55
56
57
58
59

D.7.1 Call Waiting and Recall with a Single Call Identity

Table 27: Call Waiting with Recall Scenario with a Single Call Identity

Step	Action	Reported Event	Connection Diagram
1	The call connections for the IAP are idle.		
2	The intercept subject at (202) 555-0000 receives a voice call from Party A at (202) 555-1111.	IDIAP> TerminationAttempt (2025551111 [1]) CIAP> CCOpen (CCC1 [1])	
3	The intercept subject answers the call.	IDIAP> Answer (2025550000 [1])	
4	Later, a second call arrives to alert the intercept subject from Party B at (202) 555-2222.	IDIAP> TerminationAttempt (2025552222 [2]) CIAP> CCOpen (CCC2 [2])	
5	The intercept subject answers the second call with Call Waiting.	IDIAP> Answer (2025550000 [2]) IDIAP> Change ([1,2 to 1]) CIAP> CCClose (CCC2)	
6	The intercept subject toggles back to the original call.		
7	The intercept subject ends that call by hanging up causing the held party to recall the intercept subject.	IDIAP> TerminationAttempt (2025552222 [1])	
8	The intercept subject answers the call.	IDIAP> Answer (2025550000 [1])	
9	The second call is released.	IDIAP> Release ([1]) CIAP> CCClose (CCC1)	

PN-4465-RV1

1
2
3
4
5
6
7
8
9
10
11
12
13
14
15
16
17
18
19
20
21
22
23
24
25
26
27
28
29
30
31
32
33
34
35
36
37
38
39
40
41
42
43
44
45
46
47
48
49
50
51
52
53
54
55
56
57
58
59

D.7.2 Call Waiting and Recall with Separate Leg Identities

Table 28: Call Waiting with Recall with Separate Leg Identities Scenario

Step	Action	Reported Event	Connection Diagram
1	The call connections for the IAP are idle.		
2	The intercept subject at (202) 555-0000 receives a voice call from Party A at (202) 555-1111.	IDIAP> TerminationAttempt (2025551111 [1]) CIAP> CCOpen (CCC1 [1])	
3	The intercept subject answers the call.	IDIAP> Answer (2025550000 [1])	
4	Later, a second call arrives to alert the intercept subject from Party B at (202) 555-2222.	IDIAP> TerminationAttempt (2025552222 [2]) CIAP> CCOpen (CCC2 [2])	
5	The intercept subject answers the second call with Call Waiting.	IDIAP> Answer (2025550000 [2]) IDIAP> Change ([1,2 to 1*2]) CIAP> CCClose (CCC2)	
6	The intercept subject toggles back to the original call.		
7	The intercept subject ends that call by hanging up causing the held party to recall the intercept subject.	IDIAP> Release ([1]) IDIAP> TerminationAttempt (2025552222 [2])	
8	The intercept subject answers the call.	IDIAP> Answer (2025550000 [2])	
9	The second call is released.	IDIAP> Release ([2]) CIAP> CCClose (CCC1)	

PN-4465-RV1

1
2
3
4
5
6
7
8
9
10
11
12
13
14
15
16
17
18
19
20
21
22
23
24
25
26
27
28
29
30
31
32
33
34
35
36
37
38
39
40
41
42
43
44
45
46
47
48
49
50
51
52
53
54
55
56
57
58
59

D.7.3 Call Waiting and Recall with Separate Calls

Table 29: Call Waiting with Recall with Separate Calls Scenario

Step	Action	Reported Event	Connection Diagram
1	The call connections for the IAP are idle.		
2	The intercept subject at (202) 555-0000 receives a voice call from Party A at (202) 555-1111.	IDIAP> TerminationAttempt (2025551111 [1]) CIAP> CCOpen (CCC1 [1])	
3	The intercept subject answers the call.	IDIAP> Answer (2025550000 [1])	
4	Later, a second call arrives to alert the intercept subject from Party B at (202) 555-2222.	IDIAP> TerminationAttempt (2025552222 [2]) CIAP> CCOpen (CCC2 [2])	
5	The intercept subject answers the second call with Call Waiting.	IDIAP> Answer (2025550000 [2])	
6	The intercept subject toggles back to the original call.		
7	The intercept subject ends that call by hanging up causing the held party to recall the intercept subject.	IDIAP> Release ([1]) CIAP> CCClose (CCC1) IDIAP> TerminationAttempt (2025552222 [2])	
8	The intercept subject answers the call.	IDIAP> Answer (2025550000 [2])	
9	The second call is released.	IDIAP> Release ([2]) CIAP> CCClose (CCC2)	

PN-4465-RV1

1
2
3
4
5
6
7
8
9
10
11
12
13
14
15
16
17
18
19
20
21
22
23
24
25
26
27
28
29
30
31
32
33
34
35
36
37
38
39
40
41
42
43
44
45
46
47
48
49
50
51
52
53
54
55
56
57
58
59

D.8 Call Waiting with Talking Party Disconnect

The intercept subject (S) at (202) 555-0000 receives a voice call from Party A at (202) 555-1111. The intercept subject answers the call. Later, a second call leg arrives to alert the intercept subject from Party B at (202) 555-2222. The intercept subject answers the second call leg with Call Waiting. The intercept subject toggles back to the original call. The original caller hangs up causing the held party to be connected to the intercept subject. The intercept subject answers the call. The second call leg is released.

This sequence is shown with three separate scenarios to show some variations of managing the **CallIdentity** parameter. It is shown with a single **CallIdentity** for the entire multiparty call, with a separate **CallIdentity** for each leg of a call merged into one **CallIdentity**, and with a **CallIdentity** for separate calls. The value of the **CallIdentity** is shown within square brackets, e.g., [1]. Separate calls are separated by commas, e.g., [1,2], and a call with multiple identities is shown with dots joining the constituent identities, e.g., [1•2].

PN-4465-RV1

1
2
3
4
5
6
7
8
9
10
11
12
13
14
15
16
17
18
19
20
21
22
23
24
25
26
27
28
29
30
31
32
33
34
35
36
37
38
39
40
41
42
43
44
45
46
47
48
49
50
51
52
53
54
55
56
57
58
59

D.8.1 Call Waiting with Talking Party Disconnect and a Single Call Identity

Table 30: Call Waiting with Talking Party Disconnect and a Single Call Identity Scenario

Step	Action	Reported Event	Connection Diagram
1	The call connections for the IAP are idle.		
2	The intercept subject at (202) 555-0000 receives a voice call from Party A at (202) 555-1111.	IDIAP> TerminationAttempt (2025551111 [1]) CIAP> CCOpen (CCC1 [1])	
3	The intercept subject answers the call.	IDIAP> Answer (2025550000 [1])	
4	Later, a second call leg arrives to alert the intercept subject from Party B at (202) 555-2222.	IDIAP> TerminationAttempt (2025552222 [2]) CIAP> CCOpen (CCC2 [2])	
5	The intercept subject answers the second call leg with Call Waiting.	IDIAP> Answer (2025550000 [2]) IDIAP> Change ([1,2 to 1]) CIAP> CCClose (CCC2)	
6	The intercept subject toggles back to the original call.		
7	The original caller hangs up causing the held party to be connected to the intercept subject.		
8	The second call leg is released.	IDIAP> Release ([1]) CIAP> CCClose (CCC1)	

PN-4465-RV1

1
2
3
4
5
6
7
8
9
10
11
12
13
14
15
16
17
18
19
20
21
22
23
24
25
26
27
28
29
30
31
32
33
34
35
36
37
38
39
40
41
42
43
44
45
46
47
48
49
50
51
52
53
54
55
56
57
58
59

D.8.2 Call Waiting with Talking Party Disconnect and Separate Leg Identities

Table 31: Call Waiting with Talking Party Disconnect and Separate Leg Identities Scenario

Step	Action	Reported Event	Connection Diagram
1	The call connections for the IAP are idle.		
2	The intercept subject at (202) 555-0000 receives a voice call from Party A at (202) 555-1111.	IDIAP> TerminationAttempt (2025551111 [1]) CIAP> CCOpen (CCC1 [1])	
3	The intercept subject answers the call.	IDIAP> Answer (2025550000 [1])	
4	Later, a second call leg arrives to alert the intercept subject from Party B at (202) 555-2222.	IDIAP> TerminationAttempt (2025552222 [2]) CIAP> CCOpen (CCC2 [2])	
5	The intercept subject answers the second call leg with Call Waiting.	IDIAP> Answer (2025550000 [2]) IDIAP> Change ([1,2 to 1*2]) CIAP> CCClose (CCC2)	
6	The intercept subject toggles back to the original call.		
7	The original caller hangs up causing the held party to be connected to the intercept subject.	IDIAP> Release ([1])	
8	The second call leg is released.	IDIAP> Release ([2]) CIAP> CCClose (CCC1)	

PN-4465-RV1

1
2
3
4
5
6
7
8
9
10
11
12
13
14
15
16
17
18
19
20
21
22
23
24
25
26
27
28
29
30
31
32
33
34
35
36
37
38
39
40
41
42
43
44
45
46
47
48
49
50
51
52
53
54
55
56
57
58
59

D.8.3 Call Waiting with Talking Party Disconnect and Separate Calls

Table 32: Call Waiting with Talking Party Disconnect and Separate Calls Scenario

Step	Action	Reported Event	Connection Diagram
1	The call connections for the IAP are idle.		
2	The intercept subject at (202) 555-0000 receives a voice call from Party A at (202) 555-1111.	IDIAP> TerminationAttempt (2025551111 [1]) CIAP> CCOpen (CCC1 [1])	
3	The intercept subject answers the call.	IDIAP> Answer (2025550000 [1])	
4	Later, a second call leg arrives to alert the intercept subject from Party B at (202) 555-2222.	IDIAP> TerminationAttempt (2025552222 [2]) CIAP> CCOpen (CCC2 [2])	
5	The intercept subject answers the second call leg with Call Waiting.	IDIAP> Answer (2025550000 [2])	
6	The intercept subject toggles back to the original call.		
7	The original caller hangs up causing the held party to be connected to the intercept subject.	IDIAP> Release ([1]) CIAP> CCClose (CCC1)	
8	The second call leg is released.	IDIAP> Release ([2]) CIAP> CCClose (CCC2)	

PN-4465-RV1

1
2
3
4
5
6
7
8
9
10
11
12
13
14
15
16
17
18
19
20
21
22
23
24
25
26
27
28
29
30
31
32
33
34
35
36
37
38
39
40
41
42
43
44
45
46
47
48
49
50
51
52
53
54
55
56
57
58
59

D.9 Call Held and Retrieved

The intercept subject (S) at (202) 555-0000 goes off-hook and calls Party A at 555-1111. The called party answers and they converse. The intercept subject puts the call on hold. The intercept subject retrieves the held call. The call is released.

Table 33: Call Held and Retrieved Scenario

Step	Action	Reported Event	Connection Diagram
1	The call connections for the IAP are idle.		
2	The intercept subject at (202) 555-0000 goes off-hook and...	CIAP> CCOpen (CCC1)	
3	...calls Party A at 555-1111.	IDIAP> Origination (User Input="5551111", Called Party=2025551111)	
4	The called party answers and they converse.	IDIAP> Answer ()	
5	The intercept subject puts the call on hold.		
6	The intercept subject retrieves the held call.		
7	The call is released.	IDIAP> Release CIAP> CCClose (CCC1)	

PN-4465-RV1

1
2
3
4
5
6
7
8
9
10
11
12
13
14
15
16
17
18
19
20
21
22
23
24
25
26
27
28
29
30
31
32
33
34
35
36
37
38
39
40
41
42
43
44
45
46
47
48
49
50
51
52
53
54
55
56
57
58
59

D.10 Three-Way Calling, Plus Call Turned Away

The intercept subject (S) at (202) 555-0000 goes off-hook and calls Party A at 555-1111. The called party answers and they converse. The intercept subject invokes Three-Way calling to call Party B at 555-2222. Party B answers. The three parties are joined into a conversation. Another call from Party C at 555-3333 is refused, because the intercept subject is busy. Party B at 555-2222 drops out of the call, but Party A at 555-1111 remains in the call. The call is released.

This sequence is shown with three separate scenarios to show some variations of managing the **CallIdentity** parameter. It is shown with a single **CallIdentity** for the entire multiparty call, with a separate **CallIdentity** for each leg of a call merged into one **CallIdentity**, and with a **CallIdentity** for separate calls. The value of the **CallIdentity** is shown within square brackets, e.g., [1]. Separate calls are separated by commas, e.g., [1,2], and a call with multiple identities is shown with dots joining the constituent identities, e.g., [1•2].

D.10.1 Three-Way Calling, Plus Call Turned Away with a Single Call Identity

Table 34: Three-Way Calling with a Single Call Identity Scenario (Sheet 1 of 2)

Step	Action	Reported Event	Connection Diagram
1	The call connections for the IAP are idle.		
2	The intercept subject at (202) 555-0000 goes off-hook and...	CIAP> CCOpen (CCC1 [1])	
3	...calls Party A at 555-1111.	IDIAP> Origination (User Input="5551111", Called Party=2025551111 [1])	
4	The called party answers and they converse.	IDIAP> Answer ([1])	
5	The intercept subject invokes Three-Way calling...		

PN-4465-RV1

Table 34: Three-Way Calling with a Single Call Identity Scenario (Sheet 2 of 2)

Step	Action	Reported Event	Connection Diagram
6	...to call Party B at 555-2222.	IDIAP> Origination (User Input="5552222", Called Party=2025552222 [1])	
7	Party B answers.	IDIAP> Answer ([1])	
8	The three parties are joined into a conversation.		
9	Another call from Party C 555-3333 is refused, because the intercept subject is busy.	IDIAP> TerminationAttempt (5553333 [2]) CIAP> CCOpen (CCC2 [2])	
10	Party C abandons its call attempt.	IDIAP> Release ([2]) CIAP> CCClose (CCC2)	
11	Party B 555-2222 drops out of the call, but Party A 555-1111 remains in the call.		
12	The call is released.	IDIAP> Release ([1]) CIAP> CCClose (CCC1)	

PN-4465-RV1

1
2
3
4
5
6
7
8
9
10
11
12
13
14
15
16
17
18
19
20
21
22
23
24
25
26
27
28
29
30
31
32
33
34
35
36
37
38
39
40
41
42
43
44
45
46
47
48
49
50
51
52
53
54
55
56
57
58
59

D.10.2 Three-Way Calling, Plus Call Turned Away with Separate Leg Identities

Table 35: Three-Way Calling Scenario with Separate Leg Identities (Sheet 1 of 2)

Step	Action	Reported Event	Connection Diagram
1	The call connections for the IAP are idle.		<p>The diagram shows two separate call legs, labeled S and S', each represented by a square with a smaller square inside, indicating they are idle.</p>
2	The intercept subject at (202) 555-0000 goes off-hook and...	CIAP> CCOpen (CCC1 [1])	<p>Call leg S is shown with a solid square inside, indicating it is active. A dashed line connects it to a switch symbol. A label 'CCC1 DF' points to the switch.</p>
3	...calls Party A at 555-1111.	IDIAP> Origination (User Input="5551111", Called Party=2025551111 [1])	<p>Call leg S is connected to a box labeled 'A'. A dashed line connects S to A. A label 'CCC1 DF' points to the connection.</p>
4	The called party answers and they converse.	IDIAP> Answer ([1])	<p>Call leg S is connected to a box labeled 'A'. A dashed line connects S to A. A label 'CCC1 DF' points to the connection.</p>
5	The intercept subject invokes Three-Way calling...	IDIAP> Change ([1 to 1*2])	<p>Call leg S is connected to a switch symbol. A dashed line connects S to the switch. A label 'CCC1 DF' points to the switch.</p>
6	...to call Party B at 555-2222.	IDIAP> Origination (User Input="5552222", Called Party=2025552222 [2])	<p>Call leg S is connected to a switch symbol. A dashed line connects S to the switch. The switch is connected to a box labeled 'A'. Another dashed line connects the switch to a box labeled 'B'. A label 'CCC1 DF' points to the switch.</p>
7	Party B answers.	IDIAP> Answer ([2])	<p>Call leg S is connected to a switch symbol. A dashed line connects S to the switch. The switch is connected to a box labeled 'A'. Another dashed line connects the switch to a box labeled 'B'. A label 'CCC1 DF' points to the switch.</p>
8	The three parties are joined into a conversation.		<p>Call leg S is connected to a switch symbol. A dashed line connects S to the switch. The switch is connected to a box labeled 'A'. Another dashed line connects the switch to a box labeled 'B'. A label 'CCC1 DF' points to the switch.</p>
9	Another call from Party C 555-3333 is refused, because the intercept subject is busy.	IDIAP> TerminationAttempt (5553333 [3]) CIAP> CCOpen (CCC2 [3])	<p>Call leg S' is shown with a solid square inside, indicating it is active. A dashed line connects it to a box labeled 'A'. A label 'CCC2 DF' points to the connection.</p>

PN-4465-RV1

Table 35: Three-Way Calling Scenario with Separate Leg Identities (Sheet 2 of 2)

Step	Action	Reported Event	Connection Diagram
10	Party C abandons its call attempt.	IDIAP> Release ([3]) CIAP> CCClose (CCC2)	
11	Party B 555-2222 drops out of the call, but Party A 555-1111 remains in the call.	IDIAP> Release ([2])	
12	The call is released.	IDIAP> Release ([1]) CIAP> CCClose (CCC1)	

D.10.3 Three-Way Calling, Plus Call Turned Away with Separate Calls

Table 36: Three-Way Calling with Separate Call Scenario (Sheet 1 of 2)

Step	Action	Reported Event	Connection Diagram
1	The call connections for the IAP are idle.		
2	The intercept subject at (202) 555-0000 goes off-hook and...	CIAP> CCOpen (CCC1 [1])	
3	...calls Party A at 555-1111.	IDIAP> Origination (User Input="5551111", Called Party=2025551111 [1])	
4	The called party answers and they converse.	IDIAP> Answer ([1])	
5	The intercept subject invokes Three-Way calling...	CIAP> CCOpen (CCC2 [2]) IDIAP> Change ([1,2 to 1•2]) ^a	

PN-4465-RV1

1
2
3
4
5
6
7
8
9
10
11
12
13
14
15
16
17
18
19
20
21
22
23
24
25
26
27
28
29
30
31
32
33
34
35
36
37
38
39
40
41
42
43
44
45
46
47
48
49
50
51
52
53
54
55
56
57
58
59

Table 36: Three-Way Calling with Separate Call Scenario (Sheet 2 of 2)

Step	Action	Reported Event	Connection Diagram
6	...to call Party B at 555-2222.	IDIAP> Origination (User Input="5552222", Called Party=2025552222 [2])	
7	Party B answers.	IDIAP> Answer ([2])	
8	The three parties are joined into a conversation.		
9	Another call from Party C 555-3333 is refused, because the intercept subject is busy.	IDIAP> TerminationAttempt (5553333 [3]) CIAP> CCOpen (CCC3 [3])	
10	Party C abandons its call attempt.	IDIAP> Release ([3]) CIAP> CCClose (CCC3)	
11	Party B 555-2222 drops out of the call, but Party A 555-1111 remains in the call.	IDIAP> Release ([2]) CIAP> CCClose (CCC2)	
12	The call is released.	IDIAP> Release ([1]) CIAP> CCClose (CCC1)	

Table Notes

- a. This Change message does not report the CCCs used because the call 1•2 is not delivered on a single CCC, but is rather delivered as separate and constituent calls 1 and 2.

PN-4465-RV1

D.11 Call Forwarding—No Answer on a Single System

An incoming call arrives for the intercept subject (S) at (202) 555-0000 from Party A at 555-1111. After ringing the intercept subject for a short time, the call is forwarded to Party B at 555-2222. The call is forwarded from that number to Party C at 555-3333. Party C answers the call. The call is released.

Table 37: Call Forwarding—No Answer on a Single System Scenario

Step	Action	Reported Event	Connection Diagram
1	The call connections for the IAP are idle.		
2	An incoming call arrives for the intercept subject at (202) 555-0000 from Party A at 555-1111.	IDIAP> TerminationAttempt (5551111) CIAP> CCOpen (CCC1)	
3	After ringing the intercept subject for a short time, the call is forwarded to Party B at 555-2222.	IDIAP> Redirection (5552222)	
4	The call is forwarded from that number to Party C at 555-3333. (Call forwarding is performed by Party B's service.)		
5	Party C answers the call.	IDIAP> Answer ()	
6	The call is released.	IDIAP> Release CIAP> CCClose (CCC1)	

The next scenario repeats this scenario, but shows it happening on different systems. Some system architectures may provide only the information shown in the next scenario, even when the call occurs in a single system.

PN-4465-RV1

1
2
3
4
5
6
7
8
9
10
11
12
13
14
15
16
17
18
19
20
21
22
23
24
25
26
27
28
29
30
31
32
33
34
35
36
37
38
39
40
41
42
43
44
45
46
47
48
49
50
51
52
53
54
55
56
57
58
59

D.12 Call Forwarding—No Answer on Different Systems

An incoming call arrives for the intercept subject (S) at (202) 555-0000 from Party A at 555-1111. After ringing the intercept subject for a short time, the call is forwarded to Party B at 555-2222. The call is forwarded from that number to Party C at 555-3333. Party C answers the call. The call is released.

Table 38: Call Forwarding—No Answer on Different Systems Scenario

Step	Action	Reported Event	Connection Diagram
1	The call connections for the IAP are idle.		
2	An incoming call arrives for the intercept subject at (202) 555-0000 from Party A at 555-1111.	IDIAP> TerminationAttempt (5551111) CIAP> CCOpen (CCC1)	
3	After ringing the intercept subject for a short time, the call is forwarded to Party B at 555-2222.	IDIAP> Redirection(5552222)	
4	The call is forwarded from that number to Party C at 555-3333. (Call forwarding is performed by Party B's service.)		
5	Party C answers the call.	IDIAP> Answer ()	
6	The call is released.	IDIAP> Release CIAP> CCClose (CCC1)	

PN-4465-RV1

1
2
3
4
5
6
7
8
9
10
11
12
13
14
15
16
17
18
19
20
21
22
23
24
25
26
27
28
29
30
31
32
33
34
35
36
37
38
39
40
41
42
43
44
45
46
47
48
49
50
51
52
53
54
55
56
57
58
59

D.13 Two Bearer Channels, Plus Call Transfer

The intercept subject (S) at (202) 555-0000, an ISDN subscriber calls Party A at 555-1111. Party A answers. Party B at 555-2222 calls the intercept subject. The intercept subject answers the call from Party B. The intercept subject transfers the call to Party C at 555-3333. Party C answers. Party A releases. Parties B and C release.

This sequence uses multiple call identities of managing the **CallIdentity** parameter. The value of the **CallIdentity** is shown within square brackets, e.g., [1].

Table 39: Two Bearer Channels, Plus Call Transfer Scenario (Sheet 1 of 2)

Step	Action	Reported Event	Connection Diagram
1	The call connections for the IAP are idle.		
2	The intercept subject at (202) 555-0000, an ISDN subscriber calls Party A at 555-1111.	IDIAP> Origination (User Input="5551111", Called Party=2025551111 [1]) CIAP> CCOpen (CCC1 [1])	
3	Party A answers.	IDIAP> Answer ([1])	
4	Party B at 555-2222 calls the intercept subject.	IDIAP> TerminationAttempt (5552222 [2]) CIAP> CCOpen (CCC2 [2])	
5	The intercept subject answers the call from Party B.	IDIAP> Answer (Called [2])	
6	The intercept subject transfers the call to Party C at 555-3333.	IDIAP> Origination (User Input="5553333", Called Party=2025553333 [2])	
7	Party C answers	IDIAP> Answer ([2])	

PN-4465-RV1

1
2
3
4
5
6
7
8
9
10
11
12
13
14
15
16
17
18
19
20
21
22
23
24
25
26
27
28
29
30
31
32
33
34
35
36
37
38
39
40
41
42
43
44
45
46
47
48
49
50
51
52
53
54
55
56
57
58
59

Table 39: Two Bearer Channels, Plus Call Transfer Scenario (Sheet 2 of 2)

Step	Action	Reported Event	Connection Diagram
8	Party A releases.	IDIAP> Release ([1]) CIAP> CCClose (CCC1 [1])	S
9	Parties B and C release.	IDIAP> Release ([2]) CIAP> CCClose (CCC2 [2])	S'

D.14 Speed Calling

The intercept subject (S) at (202) 555-0000 dials Party A using a speed number #12. The speed number is expanded to 555-1111. The call is abandoned.

Table 40: Speed Calling Scenario

Step	Action	Reported Event	Connection Diagram
1	The call connections for the IAP are idle.		S
2	The intercept subject at (202) 555-0000 goes off-hook...	CIAP> CCOpen (CCC1)	S
3	...and dials Party A using a speed number #12. The number is expanded to 555-1111.	IDIAP> Origination (User Input="#12", Called Party=2025551111)	S
4	The call is abandoned.	IDIAP> Release CIAP> CCClose (CCC1)	S

PN-4465-RV1

D.15 Multiple Translations on Single System

The intercept subject (S) at (202) 555-0000 dials Party A using a speed number, #12. The speed number is expanded to A' 800-555-1111. The 800 number is expanded by the switch to A" (202) 555-2222. The call is answered. The call is released.

Table 41: Multiple Translations on a Single System Scenario

Step	Action	Reported Event	Connection Diagram
1	The call connections for the IAP are idle.		
2	The intercept subject at (202) 555-0000 goes off-hook...	CIAP> CCOpen (CCC1)	
3	...and dials Party A using a speed number, #12. The number is expanded to A' 800-555-1111. This number is expanded to A" (202) 555-2222.	IDIAP> Origination (User Input="#12", Called Party=8005551111) IDIAP> Origination (Translation Input="8005551111", Called Party=2025552222)	
4	The call is answered.	IDIAP> Answer ()	
5	The call is released.	IDIAP> Release CIAP> CCClose (CCC1)	

PN-4465-RV1



1
2
3
4
5
6
7
8
9
10
11
12
13
14
15
16
17
18
19
20
21
22
23
24
25
26
27
28
29
30
31
32
33
34
35
36
37
38
39
40
41
42
43
44
45
46
47
48
49
50
51
52
53
54
55
56
57
58
59

D.16 Multiple Call Scenario

A call from Party A at 555-1111 arrives and is forwarded to Party B at 555-2222. A call from Party C at 555-3333 arrives and is forwarded to Party B at 555-2222. The first call is released. The second call is released.

This sequence uses multiple call identities of managing the **CallIdentity** parameter. The value of the **CallIdentity** is shown within square brackets, e.g., [1].

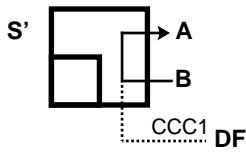
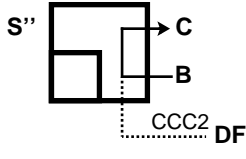
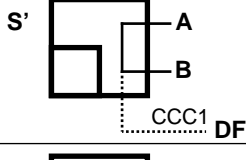
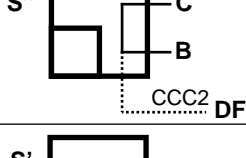
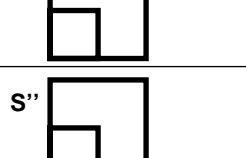
Table 42: Multiple Call Scenario

Step	Action	Reported Event	Connection Diagram
1	A call from Party A at 555-1111 arrives and is forwarded to Party B at 555-2222.	IDIAP> TerminationAttempt (5551111 [1]) IDIAP> Redirection (5552222 [1]) CIAP> CCOpen (CCC1 [1])	
2	A call from Party C at 555-3333 arrives and is forwarded to Party B at 555-2222.	IDIAP> TerminationAttempt (5553333 [2]) IDIAP> Redirection (5552222 [2]) CIAP> CCOpen (CCC2 [2])	
3	The first call is answered.	IDIAP> Answer ([1])	
4	The second call is answered.	IDIAP> Answer ([2])	
5	The first call is released.	IDIAP> Release CIAP> CCClose (CCC1 [1])	
6	The second call is released.	IDIAP> Release CIAP> CCClose (CCC2 [2])	

D.17 Simple Call Delivery to a Mobile Station

A call to the intercept subject at (202) 555-0000 arrives at a roaming intercept subject's Home System (S') from Party A at (202) 555-1111. This call is redirected to the system serving the intercept subject (S) using a Temporary Local Directory Number of (202) 555-9999. The intercept subject answers the call. The call is released. (Note: this scenario assumes that the electronic surveillance order applies to both the Redirecting System (or as TIA/EIA-41 calls it, the Originating System) and the current Serving System).

Table 43: Simple Call Delivery Scenario (Sheet 1 of 2)

Step	Action	Reported Event	Connection Diagram
1	The call connections for the IAP are idle. The intercept subject is registered on a roaming system.		
2	A call to the intercept subject at (202) 555-0000 arrives at the intercept subject's Redirecting System from Party A at (202) 555-1111.	IDIAP ₁ > TerminationAttempt (2025551111) CIAP ₁ > CCOpen (CCC1)	
3	This call is redirected to the System Serving the intercept subject using a Temporary Local Directory Number of (202) 555-9999.	IDIAP _{HLR} > TerminationAttempt (2025551111) ^a IDIAP _{HLR} > Redirection (2025559999) IDIAP ₁ > Redirection (2025559999) IDIAP ₂ > TerminationAttempt (2025559999 redirected by 2025550000) ^b CIAP ₂ > CCOpen (CCC2) ^c	

PIN-4465-RV1

1
2
3
4
5
6
7
8
9
10
11
12
13
14
15
16
17
18
19
20
21
22
23
24
25
26
27
28
29
30
31
32
33
34
35
36
37
38
39
40
41
42
43
44
45
46
47
48
49
50
51
52
53
54
55
56
57
58
59

Table 43: Simple Call Delivery Scenario (Sheet 2 of 2)

Step	Action	Reported Event	Connection Diagram
4	The intercept subject answers the call.	<p>IDIAP₁> Answer ()</p> <p>IDIAP₂> Answer (2025550000)</p>	<p>Redirecting (1)</p>
5	The call is released.	<p>IDIAP₁> Release CIAP₁> CCCclose (CCC1)</p> <p>IDIAP₂> Release CIAP₂> CCCclose (CCC2)</p>	<p>Redirecting (1)</p> <p>Serving (2)</p>

Table Notes

- a. The HLR-based IDIAP may be necessary for TSPs that allow call redirection without access to the call content.
- b. Report the Temporary Local Directory Number (or equivalent) used to route the call rather than the terminal directory number.
- c. If CCC1 and CCC2 pass through the same Delivery Function (e.g., pivoted content delivery), one of the CCCs should be eliminated. Before the subject answers, the CCC1 is the most appropriate channel. After the subject answers, CCC2 is the most appropriate channel.

PN-4465-RV1

D.18 Password Call Acceptance and Flexible Alerting

A call arrives at an intercept subject pilot number (202) 555-0000 from a party (A) at (202) 555-1111. The system prompts the calling party to enter a password. Party (A) enters a valid password, 123456. Flexible alerting alerts the intercept subject at 202-555-0000 and party (B) at 555-2222. The switch monitors their call progress tones. The intercept subject answers. The call attempt to B is automatically abandoned. The call is released.

Table 44: Password Call Acceptance and Flexible Alerting Scenario

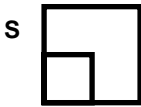
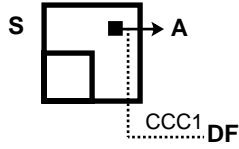
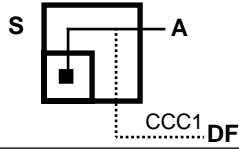
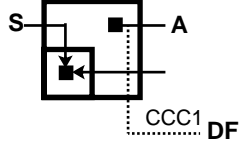
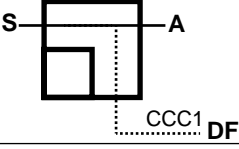
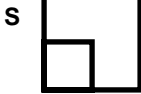
Step	Action	Reported Event	Connection Diagram
1	The call connections for the IAP are idle.		
2	A call arrives at an intercept subject pilot number (202) 555-0000 from a party (A) at (202) 555-1111. The system prompts the calling party to enter a password.	IDIAP> TerminationAttempt (2025551111) IDIAP> Answer (TrunkId) CIAP> CCOpen (CCC1)	
3	Party (A) enters a valid password, 123456.		
4	Flexible alerting alerts the intercept subject at 202-555-0000 and party (B) at 555-2222. The switch monitors their call progress tones.	IDIAP> Redirection (2025550000) IDIAP> Redirection (5552222)	
5	The intercept subject answers. The call attempt to B is automatically abandoned.	IDIAP> Answer (2025550000)	
6	The call is released.	IDIAP> Release CIAP> CCClose (CCC1)	

PN-4465-RV1

1
2
3
4
5
6
7
8
9
10
11
12
13
14
15
16
17
18
19
20
21
22
23
24
25
26
27
28
29
30
31
32
33
34
35
36
37
38
39
40
41
42
43
44
45
46
47
48
49
50
51
52
53
54
55
56
57
58
59

D.19 Password Call Acceptance and Call Forwarding

A call arrives at an intercept subject number (202) 555-0000 from a party (A) at (202) 555-1111. The system answers the call and prompts the calling party to enter a password. Party (A) enters a valid password, 123456. The call is forwarded to Party (B). The call attempt is abandoned.

Table 45: Password Call Acceptance and Call Forwarding Scenario

Step	Action	Reported Event	Connection Diagram
1	The call connections for the IAP are idle.		
2	A call arrives at an intercept subject number (202) 555-0000 from a party (A) at (202) 555-1111. The system answers the call and prompts the calling party to enter a password.	IDIAP> TerminationAttempt (2025551111) IDIAP> Answer (TrunkId) CIAP> CCOpen (CCC1)	
3	Party (A) enters a valid password, 1233456.		
4	The call is forwarded to Party (B).	IDIAP> Redirection (5552222)	
5	The call is abandoned.	IDIAP> Release CIAP> CCClose (CCC1)	



PN-4465-RV1

1
2
3
4
5
6
7
8
9
10
11
12
13
14
15
16
17
18
19
20
21
22
23
24
25
26
27
28
29
30
31
32
33
34
35
36
37
38
39
40
41
42
43
44
45
46
47
48
49
50
51
52
53
54
55
56
57
58
59

D.20 Completed Call To Busy Subscriber

Previously the subject placed a call to busy subscriber A at 555-1111. The subject goes off-hook, enters a feature code *333 indicating that the call should be completed to the busy subscriber, and goes back on-hook. Later, subscriber A becomes available. The subject is alerted with distinctive alerting. The subject answers. The call is extended to subscriber A. The call is answered. Later both parties disconnect.

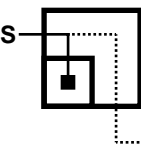
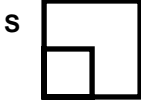
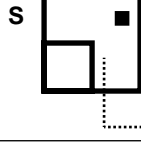
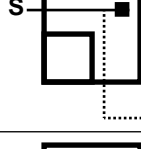
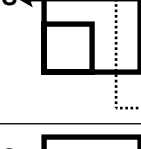
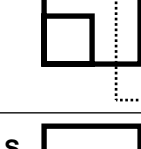
Table 46: Completed Call To Busy Subscriber

Step	Action	Reported Event	Connection Diagram
1	The call connections are idle. Previously the subject placed a call to busy subscriber A at 555-1111.		
2	The subject goes off-hook, enters a feature code *333 indicating that the call should be completed to the busy subscriber, and...	CIAP> CCOpen (CCC1) IDIAP> Origination (User Input="*333", Called Party=2025551111)	
3	...goes back on-hook.	IDIAP> Release CIAP> CCClose (CCC1)	
4	Later, subscriber A becomes available. The subject is alerted with distinctive alerting.	CIAP> CCOpen (CCC1) IDIAP> TerminationAttempt (TrunkID)	
5	The subject answers.	Answer (2025550000)	
6	The call is extended to Party A.	IDIAP> Origination (User Input="", Called Party=2025551111)	
7	The call is answered.	IDIAP> Answer ()	
8	Later both parties disconnect.	IDIAP> Release CIAP> CCClose (CCC1)	

PN-4465-RV1

1
2
3
4
5
6
7
8
9
10
11
12
13
14
15
16
17
18
19
20
21
22
23
24
25
26
27
28
29
30
31
32
33
34
35
36
37
38
39
40
41
42
43
44
45
46
47
48
49
50
51
52
53
54
55
56
57
58
59

D.21 Dialed Feature Code Digits

The intercept subject at (202) 555-0000 invokes a feature code, *222, to deactivate Call Forwarding—Busy. The status of the change is provided audibly to the intercept subject. The call is released.

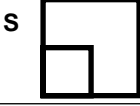
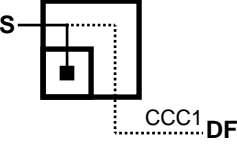
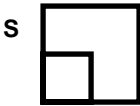
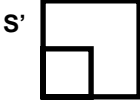

Table 47: Dialed Feature Code Digits Scenario

Step	Action	Reported Event	Connection Diagram
1	The call connections for the IAP are idle.		
2	The intercept subject at (202) 555-0000 invokes a feature code, *222. The status of the change is provided audibly to the intercept subject.	CIAP> CCOpen (CCC1) IDIAP> Origination (User Input = “*222”)	
3	The call is released.	IDIAP> Release CIAP> CCClose (CCC1)	

D.22 Call Release to Pivot

A call to intercept subject at (202) 555-0000 arrives at a roaming intercept subject’s Home System (S’) from Party A at (202) 555-1111. This call is redirected to the system serving the intercept subject (S) using a Temporary Local Directory Number of (202) 555-9999. The call is not answered and is redirected again by the redirecting system to Party B at 555-2222 (using release to pivot) to the forward-to number for an unanswered call.

Table 48: Call Release to Pivot Scenario (Sheet 1 of 2)

Step	Action	Reported Event	Connection Diagram
1	The call connections for the IAP are idle. The intercept subject is registered on a Serving System.	SSIAP _{HLR} > ServingSystem	Redirecting (1)  Serving (2) 

PN-4465-RV1

Table 48: Call Release to Pivot Scenario (Sheet 2 of 2)

Step	Action	Reported Event	Connection Diagram
2	A call to intercept subject at (202) 555-0000 arrives at the intercept subject's Redirecting System from Party A at (202) 555-1111.	IDIAP ₁ > TerminationAttempt (2025551111) CIAP ₁ > CCOpen (CCC1)	<p>Redirecting (1) S'</p> <p>Serving (2) S</p>
3	This call is redirected to the system serving the intercept subject using a Temporary Local Directory Number of (202) 555-9999.	IDIAP ₁ > Redirection (2025559999) IDIAP ₂ > TerminationAttempt (2025551111 redirected by 2025550000) CIAP ₂ > CCOpen (CCC2)	<p>Redirecting (1) S'</p> <p>Serving (2) S</p>
4	After no answer, the call is forwarded to Party B at 555-2222 using release to pivot.	IDIAP ₁ > Redirection (5552222) IDIAP ₂ > Release CIAP ₂ > CCClose (CCC2)	<p>Redirecting (1) S'</p> <p>Serving (2) S</p>
5	Party B answers the call.	IDIAP ₁ > Answer ()	<p>Redirecting (1) S'</p> <p>Serving (2) S</p>
6	The call is released.	IDIAP ₁ > Release CIAP ₁ > CCClose (CCC1)	<p>Redirecting (1) S'</p>

PN-4465-RV1

1
2
3
4
5
6
7
8
9
10
11
12
13
14
15
16
17
18
19
20
21
22
23
24
25
26
27
28
29
30
31
32
33
34
35
36
37
38
39
40
41
42
43
44
45
46
47
48
49
50
51
52
53
54
55
56
57
58
59

D.23 Intrasytem Handoff

The intercept subject hands-off within a system.

Table 49: Intrasytem Handoff Scenario

Step	Action	Reported Event	Connection Diagram
1	The intercept subject is in the conversation mode on a system.	Previously: CIAP> CCOpen (CCC1)	
2	The MS is handed off to different cell within the same system.		

D.24 Handoff to a Third System without Path Minimization

The intercept subject is in the conversation mode on an Anchor System. The anchor MSC determines the call should be handed off to an adjacent system (without path minimization). After a time, the adjacent system determines that the call should be handed off to a third system. After a time the third system determines that the call should be handed to the Anchor System. The call is released.

Table 50: Handoff to a Third System without Path Minimization Scenario (Sheet 1 of 2)

Step	Action	Reported Event	Connection Diagram
1	The intercept subject is in the conversation mode on an Anchor System.	Previously: CIAP> CCOpen (CCC1)	
2	The anchor MSC determines the call should be handed off to an adjacent system.		

PN-4465-RV1

Table 50: Handoff to a Third System without Path Minimization Scenario (Sheet 2 of 2)

Step	Action	Reported Event	Connection Diagram
3	After a time, the adjacent system determines that the call should be handed off to a third system.		
4	After a time, the third system determines that the call should be handed back to the Anchor System.		
5	The call is released.	IDIAP> Release CIAP> CCClose (CCC1)	

PN-4465-RV1

1
2
3
4
5
6
7
8
9
10
11
12
13
14
15
16
17
18
19
20
21
22
23
24
25
26
27
28
29
30
31
32
33
34
35
36
37
38
39
40
41
42
43
44
45
46
47
48
49
50
51
52
53
54
55
56
57
58
59

D.25 Connected Party Modification

While the subject is in a stable call with another party A, the other party A transfers the call to another party B at 555-2222.

Table 51: Connected Party Modification Scenario

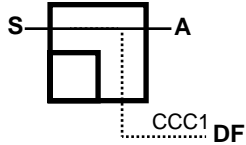
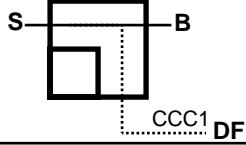
Step	Action	Reported Event	Connection Diagram
1	While the subject is in a stable call with another party A,...	Previously: CIAP> CCOpen (CCC1)	
2	...the other party A transfers the call to another party B at 555-2222.		

1
2
3
4
5
6
7
8
9
10
11
12
13
14
15
16
17
18
19
20
21
22
23
24
25
26
27
28
29
30
31
32
33
34
35
36
37
38
39
40
41
42
43
44
45
46
47
48
49
50
51
52
53
54
55
56
57
58
59

PN-4465-RV1

Annex E Information Access Scenarios - J-STD-025A

This Annex is informative and is not considered part of this Interim Standard.

Several basic circuit-mode call scenarios are described in this section. The intent of this section is to provide representative examples of reported events over a CDC and changes in connections for the CCC. This section is not an exhaustive set of examples. Each specific scenario applies to a particular service and configuration, but may be considered to be applicable to other similar services and configurations. TSPs may provide access using configurations and accesses not shown and systems are not obligated to implement particular services or accesses in the way illustrated. There may also be implementation differences providing different numbers of **CallIdentity** per scenarios. (The scenarios assume that there is one **CallIdentity** used for each CCC, unless noted otherwise.)

For the switch connection diagram conventions see [Annex D](#) on page 123.

E.1 Conference Call

The intercept subject individually calls another party, then invokes multi-party service to place the newly called party in conversation with others previously placed in communication by the intercept subject (i.e., Conference Call).

E.1.1 Conference Call (ConferencePartyChange using PartyIdentities)

In this scenario, the *ConferencePartyChange* message is used. CCC1 monitors the multi-party conference communication. The Subject Signal and Network Signal messages have been omitted to focus the reader's attention to the *ConferencePartyChange* message usage.

Note: Pay close attention to the use of commas (,) and semicolons (;). Commas are used to separate identities (Call, Party, or CCC) within a single call. Semicolons are used to separate one call, with its associated identities (Call, Party, and CCC), from another call and its associated identities.

Note: Messages in italics are optional.

Table 52: Conference Call (ConferencePartyChange using PartyIdentities) Scenario (Sheet 1 of 4)

Step	Action	Reported Event	Connection Diagram
1	The call connections for the IAP are idle.		

PN-4465-RV1

1
2
3
4
5
6
7
8
9
10
11
12
13
14
15
16
17
18
19
20
21
22
23
24
25
26
27
28
29
30
31
32
33
34
35
36
37
38
39
40
41
42
43
44
45
46
47
48
49
50
51
52
53
54
55
56
57
58
59

Table 52: Conference Call (ConferencePartyChange using PartyIdentities) Scenario (Sheet 2 of 4)

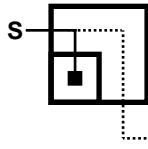
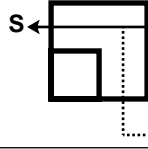
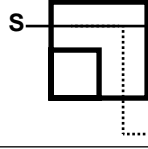
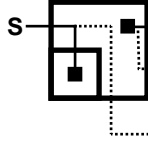
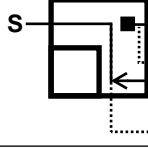
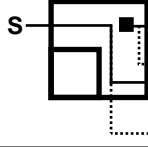
Step	Action	Reported Event	Connection Diagram
2	The intercept subject at (202) 555-0000 goes off-hook and...	CIAP> CCOpen (CallIdentity=[1], CCCIdentity=CCC1)	
3	...calls Party A at 555-1111.	IDIAP> Origination (CallIdentity=[1], Called Party=2025551111, User Input="5551111")	
4	The called party answers and they converse.	IDIAP> Answer (CallIdentity=[1])	
5	The intercept subject invokes conference calling, Party A is placed on hold, and...	CIAP> CCOpen (CallIdentity=[2], CCCIdentity=CCC2) IDIAP>ConferenceParty- Change (Removed: CallIdentity=[1], PartyIdentity=2025550000, CCCIdentity= CCC1)	
6	... calls Party B at 555-2222.	IDIAP> Origination (CallIdentity=[2], Called Party=2025552222, User Input="5552222")	
7	Party B answers and communicates with the intercept subject.	IDIAP> Answer (CallIdentity=[2])	

PN-4465-RV1

1
2
3
4
5
6
7
8
9
10
11
12
13
14
15
16
17
18
19
20
21
22
23
24
25
26
27
28
29
30
31
32
33
34
35
36
37
38
39
40
41
42
43
44
45
46
47
48
49
50
51
52
53
54
55
56
57
58
59

Table 52: Conference Call (ConferencePartyChange using PartyIdentities) Scenario (Sheet 3 of 4)

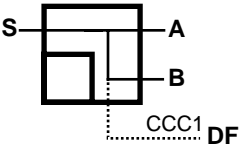
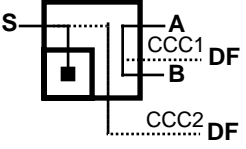
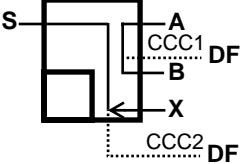
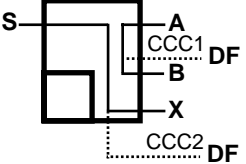
Step	Action	Reported Event	Connection Diagram
8	<p>The intercept subject requests all parties to be added to the conference.</p> <p>(Communicating parties are Parties [S, A, and B] on CCC1.)</p>	<p>IDIAP>Change (Previous: CallIdentity=[1]; CallIdentity=[2]; Resulting: CallIdentity=[1], CCCIdentity=CCC1)</p> <p>IDIAP>ConferenceParty- Change (Communicating: CallIdentity=[1], PartyIdentity=2025550000, PartyIdentity=2025551111, PartyIdentity=2025552222, CCCIdentity=CCC1)</p> <p>or (Joined: CallIdentity=[1], PartyIdentity=2025550000, PartyIdentity=2025552222, CCCIdentity=CCC1)</p> <p>CIAP>CCCclose (CCCIdentity=CCC2)</p>	
9	<p>The intercept subject invokes conference calling, the conference is placed on hold, and...</p> <p>(Communicating parties are Parties [A and B] on CCC1.)</p>	<p>CIAP>CCOpen (CallIdentity=[3], CCCIdentity=CCC2)</p> <p>IDIAP>ConferencePartyChange (Communicating: CallIdentity=[1], PartyIdentity=2025551111, PartyIdentity=2025552222, CCCIdentity=CCC1)</p>	
10	<p>...calls party X at 555-xxxx. (Communicating parties are Parties [A and B] on CCC1.)</p>	<p>IDIAP> Origination (CallIdentity=[3], Called Party=202555xxxx, User input="555xxxx")</p>	
11	<p>Party X answers and communicates with the subject. (Communicating parties are Parties [A and B] on CCC1 and Parties [S and X] on CCC2).</p>	<p>IDIAP> Answer (CallIdentity=[3])</p>	

PN-4465-RV1

1
2
3
4
5
6
7
8
9
10
11
12
13
14
15
16
17
18
19
20
21
22
23
24
25
26
27
28
29
30
31
32
33
34
35
36
37
38
39
40
41
42
43
44
45
46
47
48
49
50
51
52
53
54
55
56
57
58
59

Table 52: Conference Call (ConferencePartyChange using PartyIdentities) Scenario (Sheet 4 of 4)

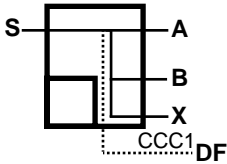
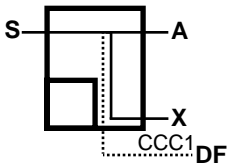
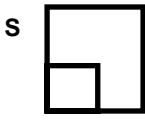
Step	Action	Reported Event	Connection Diagram
12	<p>The intercept subject requests all parties to be added to the conference.</p> <p>(Communicating parties are [S, A, B, and X] on CCC1.)</p>	<p>IDIAP>Change (Previous: CallIdentity=[1]; CallIdentity=[3]; Resulting: CallIdentity=[1], CCCIdentity=CCC1)</p> <p>IDIAP>ConferenceParty- Change (Communicating: CallIdentity=[1], PartyIdentity=2025550000, PartyIdentity=2025551111, PartyIdentity=2025552222, PartyIdentity=202555xxxx, CCCIdentity=CCC1) or (Joined: CallIdentity=[1], PartyIdentity=2025550000, PartyIdentity= 202555xxxx, CCCIdentity=CCC1)</p> <p>CIAP>CCCclose (CCCIdentity=CCC2)</p>	
13	<p>Party B hangs up from the call.</p> <p>(Communicating parties are [S,A, and X] on CCC1.)</p>	<p>IDIAP>ConferenceParty- Change (Communicating: CallIdentity=[1], PartyIdentity=2025550000, PartyIdentity=2025551111, PartyIdentity=202555xxxx, CCCIdentity=CCC1) or (Dropped: CallIdentity=[1], PartyIdentity=2025552222, CCCIdentity=CCC1)</p>	
14	<p>Later, the subject hangs up and the network releases all parties.</p>	<p>IDIAP>Release (CallIdentity=[1])</p> <p>CIAP>CCCclose (CCCIdentity=CCC1)</p>	

PN-4465-RV1

1
2
3
4
5
6
7
8
9
10
11
12
13
14
15
16
17
18
19
20
21
22
23
24
25
26
27
28
29
30
31
32
33
34
35
36
37
38
39
40
41
42
43
44
45
46
47
48
49
50
51
52
53
54
55
56
57
58
59

E.1.2 Conference Call (ConferencePartyChange using CallIdentities)

In this scenario the party identities are reported only on Origination messages, otherwise call identities are reported. The SubjectSignal and NetworkSignal messages have been omitted to focus the readers attention to the ConferencePartyChange message usage.

Note: Pay close attention to the use of commas (,) and semicolons (;). Commas are used to separate identities (Call, Party, or CCC) within a single call. Semicolons are used to separate one call, with its associated identities (Call, Party, and CCC), from another call and its associated identities.

Note: Messages in italics are optional.

Table 53: Conference Call (ConferencePartyChange using CallIdentities) Scenario (Sheet 1 of 4)

Step	Action	Reported Event	Connection Diagram
1	The call connections for the IAP are idle.		
2	The intercept subject at (202) 555-0000 goes off-hook and...	CIAP> CCOpen (CallIdentity=[1], CCCIdentity=CCC1)	
3	...calls Party A at 555-1111.	IDIAP> Origination (CallIdentity=[1], Called Party=202551111, User Input="5551111")	
4	The called party answers and they converse.	IDIAP> Answer (CallIdentity=[1])	
5	The intercept subject invokes conference calling, Party A is placed on hold, and...	CIAP> CCOpen (CallIdentity=[2], CCCIdentity=CCC2) IDIAP>ConferenceParty- Change (Communicating: CallIdentity=[1], PartyIdentity=202551111a, CCCIdentity= CCC1)	
6	... calls Party B at 555-2222.	IDIAP> Origination (CallIdentity=[2], Called Party=202552222, User Input="5552222")	

PN-4465-RV1

1
2
3
4
5
6
7
8
9
10
11
12
13
14
15
16
17
18
19
20
21
22
23
24
25
26
27
28
29
30
31
32
33
34
35
36
37
38
39
40
41
42
43
44
45
46
47
48
49
50
51
52
53
54
55
56
57
58
59

Table 53: Conference Call (ConferencePartyChange using CallIdentities) Scenario (Sheet 2 of 4)

Step	Action	Reported Event	Connection Diagram
7	Party B answers and communicates with the intercept subject.	IDIAP> Answer (CallIdentity=[2])	
8	The intercept subject requests all parties to be added to the conference. (Communicating parties are Parties [S, A, and B] on CCC1.)	IDIAP>Change (Previous: CallIdentity=[1]; CallIdentity=[2]; Resulting: CallIdentity=[1], CallIdentity=[2], CCCIdentity=CCC1) IDIAP>ConferenceParty- Change (Communicating: CallIdentity=[1], CallIdentity=[2], PartyIdentity=2025550000, PartyIdentity=2025551111, PartyIdentity=2025552222, CCCIdentity=CCC1) CIAP>CCCclose (CCCIdentity=CCC2)	
9	The intercept subject invokes conference calling, the conference is placed on hold, and... (Communicating parties are Parties [A and B] on CCC1.)	CIAP>CCOpen (CallIdentity=[3], CCCIdentity=CCC2) IDIAP>ConferencePartyChange (Communicating: CallIdentity=[1], CallIdentity=[2], PartyIdentity=2025551111a, PartyIdentity=2025552222, CCCIdentity=CCC1)	
10	...calls party X at 555-xxxx. (Communicating parties are Parties [A and B] on CCC1.)	IDIAP>Origination (CallIdentity=[3], Called Party=202555xxxx, User input= "555xxxx")	

PN-4465-RV1

Table 53: Conference Call (ConferencePartyChange using CallIdentities) Scenario (Sheet 3 of 4)

Step	Action	Reported Event	Connection Diagram
11	Party X answers and communicates with the subject. (Communicating parties are Parties [A and B] on CCC1 and Parties [S and X] on CCC2.)	IDIAP> Answer (CallIdentity=[3])	
12	The intercept subject requests all parties to be added to the conference. (Communicating parties are [S, A, B, and X] on CCC1.)	IDIAP>Change (Previous: CallIdentity=[1], CallIdentity=[2]; CallIdentity=[3]; Resulting: CallIdentity=[1], CallIdentity=[2], CallIdentity=[3], CCCIdentity=CCC1) IDIAP>ConferenceParty- Changeb (Communicating: CallIdentity=[1], CallIdentity=[2], CallIdentity=[3], PartyIdentity=2025550000, PartyIdentity=2025551111, PartyIdentity=2025552222, PartyIdentity=202555xxxx, CCCIdentity=CCC1) CIAP>CCCclose (CCCIdentity=CCC2)	
13	Party X hangs up from the call. (Communicating parties are [S,A, and B] on CCC1.)	IDIAP>ConferenceParty- Change (Communicating: CallIdentity=[1], CallIdentity=[2], PartyIdentity=2025550000c, CCCIdentity=CCC1; Dropped: CallIdentity=[3]d, PartyIdentity=202555xxxx) IDIAP>Release (CallIdentity=[3])	

PN-4465-RV1

1
2
3
4
5
6
7
8
9
10
11
12
13
14
15
16
17
18
19
20
21
22
23
24
25
26
27
28
29
30
31
32
33
34
35
36
37
38
39
40
41
42
43
44
45
46
47
48
49
50
51
52
53
54
55
56
57
58
59

Table 53: Conference Call (ConferencePartyChange using CallIdentities) Scenario (Sheet 4 of 4)

Step	Action	Reported Event	Connection Diagram
14	Later, the subject hangs up and the network releases all parties.	IDIAP>Release (CallIdentity=[1]) IDIAP>Release (CallIdentity=[2]) CIAP>CCClose (CCIdentity=CCC1)	S 

Table Notes:

- a. The PartyIdentities are needed to show which parties are on Hold.
- b. Without PartyIdentities this message is redundant with the Change message.
- c. This parameter would further clarify that the subject is not being Released with CallIdentity 3 but is remaining on the call.
- d. This means that Party X dropped with CallIdentity 3 from the conversation. However, a Release message is needed to indicate CallIdentity 3 is no longer in use and will be available for reuse at a later time.

1
2
3
4
5
6
7
8
9
10
11
12
13
14
15
16
17
18
19
20
21
22
23
24
25
26
27
28
29
30
31
32
33
34
35
36
37
38
39
40
41
42
43
44
45
46
47
48
49
50
51
52
53
54
55
56
57
58
59

PN-4465-RV1

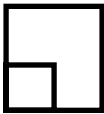
E.1.3 Conference Call (Connection/ConnectionBreak using PartyIdentities)

The SubjectSignal and NetworkSignal messages have been omitted to focus the readers attention to the Connection and ConnectionBreak messages.

Note: Pay close attention to the use of commas (,) and semicolons (;). Commas are used to separate identities (Call, Party, or CCC) within a single call. Semicolons are used to separate one call, with its associated identities (Call, Party, and CCC), from another call and its associated identities.

Note: Messages in italics are optional.

Table 54: Conference Call (Connection/ConnectionBreak using PartyIdentities) Scenario (Sheet 1 of 3)

Step	Action	Reported Event	Connection Diagram
1	The call connections for the IAP are idle.		
2	The intercept subject at (202) 555-0000 goes off-hook and...	CIAP> CCOpen (CallIdentity=[1], CCCIdentity=CCC1)	
3	...calls Party A at 555-1111.	IDIAP> Origination (CallIdentity=[1], Called Party=2025551111, User Input="5551111")	
4	The called party answers and they converse.	IDIAP> Answer (CallIdentity=[1])	
5	The intercept subject invokes conference calling, Party A is placed on hold, and...	CIAP> CCOpen (CallIdentity=[2], CCCIdentity=CCC2) IDIAP>ConnectionBreaka (CallIdentity=[1], RemovedParties: PartyIdentity=2025550000; RemainingParties: PartyIdentity=2025551111)	
6	... calls Party B at 555-2222.	IDIAP> Origination (CallIdentity=[2], Called Party=2025552222, User Input="5552222")	

PN-4465-RV1

1
2
3
4
5
6
7
8
9
10
11
12
13
14
15
16
17
18
19
20
21
22
23
24
25
26
27
28
29
30
31
32
33
34
35
36
37
38
39
40
41
42
43
44
45
46
47
48
49
50
51
52
53
54
55
56
57
58
59

Table 54: Conference Call (Connection/ConnectionBreak using PartyIdentities) Scenario
(Sheet 2 of 3)

Step	Action	Reported Event	Connection Diagram
7	Party B answers and communicates with the intercept subject.	IDIAP> Answer CallIdentity={2}	
8	The intercept subject requests all parties to be added to the conference. (Communicating parties are Parties [S, A, and B] on CCC1.)	IDIAP>Change (Previous: CallIdentity={1}; CallIdentity={2}; Resulting: CallIdentity={1}, CCCIdentity=CCC1) IDIAP>Connectionb CallIdentity={1}, ConnectedParties: PartyIdentity=2025550000, PartyIdentity=2025551111, PartyIdentity=2025552222) CIAP>CCCclose (CCCIdentity=CCC2)	
9	The intercept subject invokes conference calling, the conference is placed on hold, and... (Communicating parties are Parties [A and B] on CCC1.)	CIAP>CCOpen (CallIdentity={3}, CCCIdentity=CCC2) IDIAP>ConnectionBreaka (CallIdentity={1}, RemovedParties: PartyIdentity=2025550000; RemainingParties: PartyIdentity=2025551111, PartyIdentity=2025552222)	
10	...calls party X at 555-xxxx. (Communicating parties are Parties [A and B] on CCC1.)	IDIAP> Origination (CallIdentity={3}, Called Party=202555xxxx, User input= "555xxxx")	
11	Party X answers and communicates with the subject. (Communicating parties are Parties [A and B] on CCC1 and Parties [S and X] on CCC2.)	IDIAP> Answer (CallIdentity={3})	

PN-4465-RV1

1
2
3
4
5
6
7
8
9
10
11
12
13
14
15
16
17
18
19
20
21
22
23
24
25
26
27
28
29
30
31
32
33
34
35
36
37
38
39
40
41
42
43
44
45
46
47
48
49
50
51
52
53
54
55
56
57
58
59

Table 54: Conference Call (Connection/ConnectionBreak using PartyIdentities) Scenario (Sheet 3 of 3)

Step	Action	Reported Event	Connection Diagram
12	The intercept subject requests all parties to be added to the conference. (Communicating parties are [S, A, B, and X] on CCC1.)	IDIAP>Change (Previous: CallIdentity=[1]; CallIdentity=[3]; Resulting: CallIdentity=[1], CCCIdentity=CCC1) IDIAP>Connectionb (CallIdentity=[1], ConnectedParties: PartyIdentity=2025550000, PartyIdentity=2025551111, PartyIdentity=2025552222, PartyIdentity=202555xxxx) CIAP>CCCclose (CCCIdentity=CCC2)	
13	Party B hangs up from the call. (Communicating parties are [S,A, and X] on CCC1.)	IDIAP>ConnectionBreakc (CallIdentity=[1], RemainingParties: PartyIdentity=2025550000, PartyIdentity=2025551111, PartyIdentity=202555xxxx; DroppedParties: PartyIdentity=2025552222)	
14	Later, the subject hangs up and the network releases all parties.	IDIAP>Release (CallIdentity=[1]) CIAP>CCCclose (CCCIdentity=CCC1)	

Table Notes:

- a. This message can be constructed three ways: 1.) Report both Remaining and Removed parties. 2.) Report only Remaining parties. 3.) Report only Removed parties.
- b. This message is redundant because all parties must follow their call identities when merged, which is reported by the Change message.
- c. This message can be constructed three ways: 1.) Report both Remaining and Dropped parties. 2.) Report only Remaining parties. 3.) Report only Dropped parties.

PN-4465-RV1

1
2
3
4
5
6
7
8
9
10
11
12
13
14
15
16
17
18
19
20
21
22
23
24
25
26
27
28
29
30
31
32
33
34
35
36
37
38
39
40
41
42
43
44
45
46
47
48
49
50
51
52
53
54
55
56
57
58
59

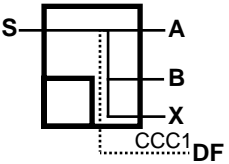
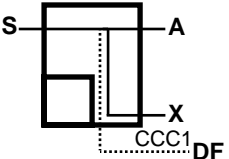
1 **E.2 Call Waiting**
2
3

4 The intercept subject (S) at (202) 555-0000 originates a voice call to Party A
5 at (202) 555-1111. Party A answers the call. Later, a second call arrives to
6 alert the intercept subject from Party B at (202) 555-2222. The intercept
7 subject answers the second call with Call Waiting. The intercept subject
8 toggles back to the original call. The intercept subject ends that call by
9 hanging up causing the held party to recall the intercept subject. The intercept
10 subject answers the call. The second call is released.

11
12 This scenario shows each call with its own CallIdentity. This scenario
13 contains no merging or splitting of CallIdentities and therefore the Change
14 message is not required to be triggered. This scenario shows an example of
15 the use of a single CCCIdentity. Therefore, CCClose and CCOpen messages
16 are used to maintain the association between the CCCIdentity and two CallI-
17 dentities.
18
19
20
21
22
23
24
25
26
27
28
29
30
31
32
33
34
35
36
37
38
39
40
41
42
43
44
45
46
47
48
49
50
51
52
53
54
55
56
57
58
59

PN-4465-RV1

E.2.1 Call Waiting with Recall (NetworkSignal and SubjectSignal)

Table 55: Call Waiting with Recall Scenario (Sheet 1 of 2)

Step	Action	Reported Event	Connection Diagram
1	The call connections for the IAP are idle.		
2	The intercept subject at (202) 555-0000 goes off-hook and... ...hears dial-tone.	CIAP>CCOpen (CallIdentity=[1] CCCIdentity=CCC1) NSIAP>NetworkSignal (CallIdentity=[1] AudibleSignal=1)	
3	calls Party A at 555-1111 andhears ring-back tone.	IDIAP>Origination (CallIdentity=[1], CalledParty= 2025551111 User Input ="5551111") NSIAP>NetworkSignalA (CallIdentity=[1] AudibleSignal=3)	
4	The called party answers the call and they converse.	IDIAP>Answer (CallIdentity=[1] PartyIdentity=2025551111)	
5	Later, a second call arrives from Party B at (202) 555-2222 andthe intercept subject hears call waiting tone.	IDIAP>TerminationAttempt (CallIdentity=[2] PartyIdentity=2025552222) NSIAP>NetworkSignal (CallIdentity=[2] AlertingSignal=6)	
6	The intercept subject answers the second call with Call Waiting.	ISSIAP>SubjectSignal (CallIdentity=[1], Signal: (Switchhook Flash="Flash")) CIAP>CCClose (CCCIdentity=CCC1) CIAP>CCOpen (CallIdentity=[2] CCCIdentity=CCC1) IDIAP>Answer (CallIdentity=[2] PartyIdentity=2025550000)	

PN-4465-RV1

1
2
3
4
5
6
7
8
9
10
11
12
13
14
15
16
17
18
19
20
21
22
23
24
25
26
27
28
29
30
31
32
33
34
35
36
37
38
39
40
41
42
43
44
45
46
47
48
49
50
51
52
53
54
55
56
57
58
59

Table 55: Call Waiting with Recall Scenario (Sheet 2 of 2)

Step	Action	Reported Event	Connection Diagram
7	The intercept subject toggles back to the original call.	ISSIAP>SubjectSignal (CallIdentity=[2], Signal: (SwitchhookFlash="Flash")) CIAP>CCCclose (CCCIdentity=CCC1) CIAP>CCOpen (CallIdentity=[1] CCCIdentity=CCC1)	
8	The intercept subject ends that call by hanging up ...	IDIAP>Release (CallIdentity=[1]) CIAP>CCCclose (CCCIdentity=CCC1)	
9	... causing the held party to recall the intercept subject with alerting.	IDIAP>TerminationAttempt (CallIdentity=[2] PartyIdentity=2025552222) NSIAP>NetworkSignal (CallIdentity=[2] AlertingSignal=1) CIAP>CCOpen (CallIdentity=[2] CCCIdentity=CCC1)	
10	The intercept subject answers the call.	IDIAP>Answer (CallIdentity=[2] PartyIdentity=2025550000)	
11	Later, the second call is released.	IDIAP>Release (CallIdentity=[2]) CIAP> CCCclose (CCCIdentity=CCC1)	

Table Notes:

a. This message is used when the subject's switch receives a signal message and applies ring-back tone to the subject. If ring-back tone is applied in-band from the second TSP's switch then this message would not be generated by the subject's switch.

PN-4465-RV1

E.3 Multi-stage Dialing (DialedDigitExtraction)

The intercept subject originates a call through a secondary TSP. The secondary TSP answers the call and prompts the intercept subject to enter the destination number and calling card number. Party A answers, the two parties converse, then the call is ended.

Table 56: Multi-stage Dialing (DialedDigitExtraction) Scenario (Sheet 1 of 2)

Step	Action	Reported Event	Connection Diagram
1	The call connections for the IAP are idle.		
2	The intercept subject at (202) 555-0000 goes off-hook and... ...hears dial-tone	CIAP>CCOpen (CallIdentity=[1], CCCIdentity=CCC1) NSIAP>NetworkSignal (CallIdentity=[1], AudibleSignal=1)	
3	...calls a TSP switch at 1-800-555-1111.	IDIAP> Origination (CallIdentity=[1], Called Party=8005551111, User Input="18005551111") NSIAP>NetworkSignala (CallIdentity=[1], AudibleSignal=3)	
4	The TSP switch answers and... ...prompts the intercept subject to enter the destination number followed by a # key, then a calling card number followed by a # key.	IDIAP>Answer (CallIdentity=[1]) (See footnote)b	
5	The intercept subject enters "404-555-1111#", then "1234-5678-9876#" within 20 seconds.	ISSIAP>DialedDigitExtractionc (CallIdentity=[1], Digits="4045551111#12345678 9876#")	
6	The call is routed to Party A.	(No reportable events)	
7	Party A answers and communicates with the intercept subject.	(No reportable events)	

PN-4465-RV1

1
2
3
4
5
6
7
8
9
10
11
12
13
14
15
16
17
18
19
20
21
22
23
24
25
26
27
28
29
30
31
32
33
34
35
36
37
38
39
40
41
42
43
44
45
46
47
48
49
50
51
52
53
54
55
56
57
58
59

Table 56: Multi-stage Dialing (DialedDigitExtraction) Scenario (Sheet 2 of 2)

Step	Action	Reported Event	Connection Diagram
8	The call is ended.	IDIAP>Release (CallIdentity=[1]) CIAP>CCClose (CCIdentity=CCC1)	

Table Notes:

a. This message is used when the subject's switch receives a signal message and applies ring-back tone to the subject. If the ring-back tone is applied in-band from the second TSP's switch then this message would not be generated by the subject's switch.

b. No messages are provided from the intercept subject's originating system because these events are occurring at the secondary TSP system, which is not performing surveillance.

c. If the intercept subject pauses more than twenty seconds or if the number of digits exceeds 32, then multiple DialedDigitExtraction messages would be sent.

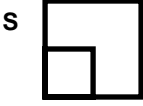
1
2
3
4
5
6
7
8
9
10
11
12
13
14
15
16
17
18
19
20
21
22
23
24
25
26
27
28
29
30
31
32
33
34
35
36
37
38
39
40
41
42
43
44
45
46
47
48
49
50
51
52
53
54
55
56
57
58
59

PN-4465-RV1

Annex F Optional Messages

This Annex is informative and is not considered part of this Interim Standard.

F.1 ConnectionTest Message

The ConnectionTest message is an optional message that may be used to verify the connectivity of the CDC. This message may be sent during the provisioning process or at any other time.

The ConnectionTest message may be triggered when:

- a. manually invoked,
- b. periodically at an implementation specific interval, or
- c. automatically upon maintenance events.

The ConnectionTest message includes the following parameters:

Table 57: ConnectionTest Message Parameters

Parameter	MOC	Usage
CaseIdentity	O	Include to identify an associated Intercept Subject.
IAPSystemIdentity	O	Included to identify the system containing the IAP when the underlying data carriage does not imply that system.
TimeStamp	M	Identifies the date and time that the event was detected.
Memo	O	Include any information that may be useful for the TSP to communicate to the LEA.

```

ConnectionTest ::= [11] SEQUENCE {
    [0] CaseIdentity                OPTIONAL,
    [1] IAPSystemIdentity           OPTIONAL,
    -- include to identify the system containing the Intercept
    -- Access
    -- Function when the underlying data carriage does not imply
    -- that system.
    [2] TimeStamp,
    memo [3] VisibleString (SIZE (1..255)) OPTIONAL
}
    
```

PN-4465-RV1

1
2
3
4
5
6
7
8
9
10
11
12
13
14
15
16
17
18
19
20
21
22
23
24
25
26
27
28
29
30
31
32
33
34
35
36
37
38
39
40
41
42
43
44
45
46
47
48
49
50
51
52
53
54
55
56
57
58
59

Annex G Possible e-Interface Delivery Methods

This Annex is informative and is not considered part of this Interim Standard.

1
2
3
4
5
6
7
8
9
10
11
12
13
14
15
16
17
18
19
20
21
22
23
24
25
26
27
28
29
30
31
32
33
34
35
36
37
38
39
40
41
42
43
44
45
46
47
48
49
50
51
52
53
54
55
56
57
58
59

PN-4465-RV1

Annex H LAES Administrative Interfaces

This Annex is informative and is not considered part of this Interim Standard.

T1M1.5 has been working on a standard for the LAES administrative interfaces entitled *Operations, Administration, Maintenance and Provisioning (OAM&P)—Extension to Generic Network Information Model for Interfaces Between Service Provider Administrative System and Network Elements for Lawfully Authorized Electronic Surveillance*.

Refer to the following document or the latest version for information regarding the Reference Point *a* and Reference Point *c*:

ANSI T1.260-1998

This document is available from:

T1 Secretariat
1200 G St. NW Suite 500
Washington, DC 20005

PN-4465-RV1

1
2
3
4
5
6
7
8
9
10
11
12
13
14
15
16
17
18
19
20
21
22
23
24
25
26
27
28
29
30
31
32
33
34
35
36
37
38
39
40
41
42
43
44
45
46
47
48
49
50
51
52
53
54
55
56
57
58
59

1 Symbols
2 μ -law encoding 80
3 Numerics
4 3.1 kHz audio 80
5 bearer service 75
6 800-number translation 53
7 scenario 150
8
9 A
10 a-interface **38**
11 abandoned **5**, 24, 57
12 abbreviated dialing
13 scenario 149
14 Abstract Syntax Notation One 63
15 access **5**
16 bridged 89
17 looped 89
18 Access Function 5, 17, 18, 20, 35, **37**, 37, 38, 39, 69, 88, 89, 90, 97, 118
19 AF **5**
20 agent **5**, 40, 40, 77
21 answering a call scenario 154, 155
22 making a call scenario 156
23 alerting
24 multiple parties scenario 154
25
26 AMPS **5**
27 AMPS-based 77
28 analog facility 90, 92, 94, 118
29 Anchor System 159, 160
30 announcement 6, 27
31 ANSI **5**
32 ANSI T1.607 **3**
33 Answer 21, **40**, 64, **64**, 129, 130, 131, 133, 134, 135, 137, 138, 139, 140, 141, 142, 143, 144,
34 145, 146, 147, 148, 150, 151, 153, 154, 155, 156, 158, 163, 166, 167, 170, 171, 174, 175, 176
35 ISUP 105
36 answer
37 (action) 5, 7, 27, 60, 104, 118, 119, 124, 125, 126, 128, 131, 132, 136, 140, 141, 146, 147,
38 148, 150, 152, 153, 154, 155, 157
39 (signal) 105, 111
40 indication 105
41 LAESMessage **64**
42 timer 105
43 answering 105, 113, 115
44 PartyIdentity
45 Answer 40, 46, **64**
46 answering party **5**
47 Anticipatory **118**
48 appearanceId **77**
49
50
51
52
53
54
55
56
57
58
59

appearances	77	1
APPLICATION	63 , 63	2
ASN.1	5 , 63	3
associate	5	4
asynchronous data	80	5
Asynchronous Transfer Mode	5	6
ATM	5 , 93, 94, 95, 96	7
attendant recall	40, 60	8
automatic callback		9
scenario	156	10
automatic recall	12	11
scenario	156	12
availability	21, 24	13
Awaiting Answer	124	14
B		15
B-channel	5	16
b-interface	38	17
Basic Encoding Rules	63	18
bearer channels		19
scenario	148	20
bearer service	80, 97	21
3.1 kHz audio	75	22
speech	75	23
BearerCapability	75 , 78	24
Answer	40, 64	25
circuit-mode vs. packet-mode	96	26
Origination	54, 69	27
Redirection	56, 71	28
TerminationAttempt	60, 73	29
bearerCapInfoElement	75	30
BER	5 , 63	31
BRI	5	32
bridged access	89	33
busy	60	34
scenario	141	35
C		36
C-conditional	39	37
c-interface	39	38
CALEA	i, xiii, 1, 5 , 6, 7, 8, 9, 10, 14, 16	39
call	5	40
busy scenario	141	41
simple incoming scenario	131	42
simple outgoing scenario	129	43
call abandoned		44
scenario	127, 128	45
call and service processing	21	46

1 call appeaances
2 scenario *148*
3
4 call appearance **5**, 19, 24, 77
5 call appearances
6 scenario *148, 151*
7
8 call associated and non-call associated services 16
9 call associated services 16
10 call attempt
11 abandoned *128*
12 access 27
13 answered 7
14 answered by network 27
15 incomplete 9
16 unanswered 5, 6, *128*
17
18 call completion to a busy suscriber scenario *156*
19
20 call content **5**
21 channel **5**
22 delivery delay *118*
23 distribution *119*
24
25 call data
26 channel **6**
27 distribution *122*
28
29 call deflection **6**, 22, 28, 56
30
31 call delivery **6**, 28, 56
32 scenario *152*
33
34 call diversion **6**, 22, 28, 56
35
36 call forwarding **6**, 22, 28, 56
37 activation scenario *157*
38 scenario *151, 155*
39 scenario on different systems *147*
40 single system scenario *146*
41
42 call fowarding
43 chained scenario *151*
44
45 call hold
46 scenario *140*
47
48 call progress tones 27
49
50 call releast to pivot scenario *157*
51
52 call retrieval
53 scenario *140*
54
55 call screening
56 scenario *154, 155*
57
58 call transfer **6**
59 scenario *148*
60
61 call waiting
62 deluxe 56
63
64 recall scenario *132*
65

scenario <i>132, 136</i>	1
called	2
directory number <i>77</i>	3
party 6	4
PartyIdentity	5
Origination <i>54, 66, 69</i>	6
TerminationAttempt <i>60, 73</i>	7
Called Party	8
Origination <i>128, 129, 130, 140, 141, 142, 143, 144, 145, 148, 149, 150, 156, 163, 166, 170, 176</i>	9
call-identifying information <i>1, 5, 6, 6, 8, 10, 16, 16, 18, 19, 20, 24, 33, 37</i>	10
Intercept Access Point <i>9, 21</i>	11
CallIdentity 75	12
Answer <i>40, 46, 64</i>	13
CCOpen <i>43, 65</i>	14
Change 44, 52, 65	15
circuit-mode vs. packet-mode <i>96</i>	16
correlation <i>17</i>	17
multiple per call <i>123, 162</i>	18
one per scenario assumption <i>123, 162</i>	19
Origination <i>54, 66, 67, 68, 69</i>	20
PacketEnvelope <i>55, 70</i>	21
Redirection <i>56, 71</i>	22
Release <i>57, 71</i>	23
Resulting <i>44, 52</i>	24
TerminationAttempt <i>60, 73</i>	25
callIdentity	26
PacketEnvelope 70	27
calling	28
directory number <i>77</i>	29
party 6	30
PartyIdentity	31
Origination <i>54, 66, 68, 69</i>	32
TerminationAttempt <i>60, 73</i>	33
callingCardNum 77	34
carrier access code <i>79</i>	35
carrier identification code <i>79</i>	36
CaseIdentity 75	37
Answer <i>40, 46, 64</i>	38
CCCclose <i>41, 65</i>	39
CCOpen <i>43, 65</i>	40
Change <i>44, 47, 48, 49, 52, 59, 65</i>	41
ConnectionTest <i>178</i>	42
Origination <i>54, 66, 67, 68, 69</i>	43
PacketEnvelope <i>55, 70</i>	44
Redirection <i>56, 71</i>	45
	46
	47
	48
	49
	50
	51
	52
	53
	54
	55
	56
	57
	58
	59

1 Release 57, 71
2 ServingSystem 58, 72
3 TerminationAttempt 60, 73
4
5 **CCC 5, 6**
6 channel exhaustion 33
7 congestion 33
8 exhaustion **33**
9 lack of CDC synchronization 33
10 loss of content 24
11 synchronization with CDC 33
12 unique identity 20
13
14 **CCCIIdentity 76**
15 CCClose 41, 65
16 CCOpen 43
17 Change 44, 65
18 Resulting 44
19
20 **CCClose 41, 64, 65, 102, 110, 114, 116, 123, 127, 128, 129, 130, 131, 133, 134, 135, 137, 138,**
21 **139, 140, 142, 144, 145, 146, 147, 149, 150, 151, 153, 154, 155, 156, 157, 158, 160, 164, 168,**
22 **171, 174, 175**
23
24 **ccClose 64**
25
26 **CCIAP 28**
27
28 **CCIR 6, 10**
29
30 **CCITT 6, 10**
31
32 **CCOpen 42, 64, 65, 101, 108, 113, 116, 123**
33 (CCC1) *127, 128, 129, 130, 131, 133, 134, 135, 137, 138, 139, 140, 141, 143, 144, 146,*
34 *147, 148, 149, 150, 151, 152, 154, 155, 156, 157, 158, 159, 161, 163, 166, 170, 174,*
35 *176*
36 (CCC2) *133, 134, 135, 137, 138, 139, 142, 143, 145, 148, 151, 152, 158, 174*
37 circuit-mode vs. packet-mode 96
38
39 **ccOpen 64**
40
41 **CCT 6**
42
43 **CDC 6, 6**
44 congestion 33
45 lack of CCC synchronization 33
46 synchronization with CCC 33
47
48 **CDMA 6, 29**
49 **CDPD 29, 55**
50
51 **cell 6**
52 **Cellular Digital Packet Data 29**
53 **CF 6**
54 Change 21, **44**, 64, 65
55 call waiting *133, 134, 137, 138*
56 **change 64**
57 **channel 7**
58 **channel exhaust**
59 CCC 33

CDC (congestion) 33	1
CHOICE 63, 82	2
BearerCapability 75	3
CCIdentity 76	4
CCOpen 65	5
LAESMessage 64	6
Origination 66, 69	7
PacketEnvelope 70	8
CIAP 7, 24, 25, 26, 27, 28, 83	9
circuit 7	10
Circuit IAP 24, 24, 24, 26	11
Circuit Intercept Access Point 7	12
circuit-mode 7, 24, 26, 41, 42, 43, 55, 57, 60, 65, 94, 96	13
class 63, 63	14
APPLICATION 63	15
CONTEXT 63	16
PRIVATE 63	17
UNIVERSAL 63	18
CLLI code 75	19
coin 77	20
Collection Function 6, 18, 19, 20, 29, 30, 33, 35, 37, 38, 38, 39, 80, 87, 90, 91, 97, 99, 102, 104, 105, 107, 109, 110, 111, 112, 113, 115, 118, 119, 122	21
collection function 7	22
combCCC 76	23
combined 19, 19, 76, 89, 97, 117	24
Commission 7	25
CommunicatingIdentity 46	26
communication 7	27
communication intercept 7	28
Communications Assistance for Law Enforcement Act i, xiii, 1, 5	29
compatibility guidelines 80	30
complete 7	31
completed call To busy subscriber scenario 156	32
conditional 39	33
conference calling 26	34
party hold, join, drop 11	35
Conference Circuit IAP 24, 28	36
ConferencePartyChange 45	37
ConferencePartyChange message	38
CommunicatingIdentity 46	39
DroppedIdentity 46	40
HoldIdentity 46	41
JoinedIdentity 46	42
congestion	43
CCC 33	44
CDC 33	45

1 connected party modification scenario *161*
2 Connection *47*
3 connection *7*
4 ConnectionBreakInformation *47, 48*
5 DroppedParties *48*
6 RemainingParties *48*
7 RemovedIdentities *47, 48*
8 RemovedParties *47, 48*
9 connectionless service *96*
10 ConnectionTest *178*
11 connnection-oriented service *96*
12 constructor *63*
13 content *7, 16*
14 subject-initiated conference calls *7*
15 surveillance service *16, 23*
16 ContentType
17 CCOpen *43*
18 CONTEXT *63, 63*
19 context
20 PartyIdentity *77*
21 controlling party *7*
22 CSU *7, 90*
23 C-tone *See also* DTMF C-tone
24 cut-through
25 full *7*
26 partial *7*
27 D
28 D-channel *7*
29 d-interface *39, 88*
30 data network *95*
31 DC *7*
32 decadic dial pulse *120*
33 decimal quad notation *77*
34 decryption *24*
35 dedicated circuit *97*
36 CCC delivery *98*
37 dedicated data circuit CDC delivery *121*
38 dedicated data link CDC delivery *122*
39 deflection *See also* call deflection
40 delayed delivery *118*
41 delivery
42 bearer service *116*
43 delayed *118*
44 signaling for *118*
45 *See also* call delivery
46 Delivery Function *7, 18, 35, 37, 37, 39, 85, 87, 88, 89, 90, 91, 97, 101, 102, 105, 107, 109,*
47
48
49
50
51
52
53
54
55
56
57
58
59

<i>110, 111, 113, 114, 118, 119, 122, 153</i>	1
destination 6, 7, 16	2
destinationAddress 70	3
DF 7	4
dialed digit extraction 8	5
message 49	6
message 49	7
Digits 49	8
Dialed Feature Code Digits	9
Scenario <i>157</i>	10
direction 6, 8, 16	11
directory number <i>77, 90, 96</i>	12
disconnect 8, 120	13
diversion <i>See also</i> call diversion	14
dn 77	15
DNIC <i>77</i>	16
DroppedIdentity 46	17
DS-0 <i>92, 93, 94, 95, 96</i>	18
DSU 8, 90	19
DTMF 8, 94, 120	20
digits <i>120</i>	21
DTMF C-tone <i>99, 100, 102, 104, 112, 119, 120</i>	22
frequency pairs <i>120</i>	23
signaling procedures <i>119</i>	24
Dual-Tone Multi-Frequency 8	25
E	26
e-interface 39, 88, 89, 90	27
E.164 <i>75</i>	28
E.164 address of node <i>76</i>	29
E.212 number <i>77</i>	30
electronic communications 8	31
electronic messaging services 8	32
Electronic Serial Number <i>77</i>	33
electronic storage 8	34
electronic surveillance 1, 8	35
en bloc <i>129</i>	36
encoding	37
objectives <i>62</i>	38
parameter identifier <i>63</i>	39
encryption <i>24</i>	40
equipment port <i>77</i>	41
esn 77	42
existing messages <i>81</i>	43
EXPLICIT 63, 64, 65, 69, 71, 73	44
extend the protocol <i>63</i>	45
extension number <i>27</i>	46
	47
	48
	49
	50
	51
	52
	53
	54
	55
	56
	57
	58
	59

1 external network 53
2 F
3 f3100HzAudio 75
4 facsimile 80
5 FCC 99-230, CC Docket No. 97-213 1, 7, 8, 9, 11, 13, 14, 18, 22, 23, 28, 32
6 feature code **8**
7 dialed digits 69
8 scenario 157
9 feature code dialed 53
10 Feature Group D 8
11 FG-D **8**
12 FGD 94
13 flash 120
14 flexible alerting
15 scenario 154
16 forwarding *See also* call forwarding
17 frame relay 92, 94, 95
18 functional entity **8**, 36
19 G
20 G.711 **3**, 80
21 GeneralizedTime 79
22 genericAddress **77**
23 genericDigits **77**
24 genericName **77**
25 government **9**
26 Group 3 Fax 80
27 GSM-based **9**, 29, 55, 77
28 gsmSMSShortMessageService **70**
29 H
30 handoff **9**, 14
31 into a system scenario 159
32 scenario 159
33 handover *See also* handoff
34 HDLC **9**, 95
35 hexadecimal string 77
36 high layer compatibility 78
37 HLR **9**, 9, 88
38 hold
39 scenario 140
40 hold recall 12, 40, 60
41 HoldIdentity 46
42 Home Location Register **9**
43 Home System **9**, 12, 85, 87, 152, 157
44 intercept access points 84
45 hot line **54**, 69
46 hotel/motel 77
47
48
49
50
51
52
53
54
55
56
57
58
59

Hz	9	1
I		2
IAP	9, 10, 24, 83, 97, 98, 104, 105, 107, 109, 110, 111, 113, 114, 124, 128, 129, 130, 131, 133, 134, 135, 137, 138, 139, 140, 141, 143, 144, 146, 147, 148, 149, 150, 152, 154, 155, 157, 162, 166, 170, 174, 176	3 4 5 6
IAPs	84	7
IAPSystemIdentity	76	8
Answer	40, 46, 64	9 10
CCClose	41, 65	11
CCOpen	43, 65	12
Change	44, 47, 48, 49, 52, 59, 65	13
ConnectionTest	178	14
Origination	54, 66, 67, 68, 69	15
PacketEnvelope	55, 70	16
Redirection	56, 71	17
Release	57, 71	18
ServingSystem	58, 72	19
TerminationAttempt	60, 73	20 21 22
identifier encoding	63	23
IDIAP	9, 21, 22, 24, 83, 88	24
idle state	9	25
imei	77	26
IMPLICIT	63, 64	27
imsi	77	28
IN	9	29
incoming calls	88	30
incomplete	9	31
call attempts	24	32
calls	53	33
indCCC	76	34
indRecvCCC	76	35
indXmitCCC	76	36
information service	10	37
input		38
Origination	54, 66, 69	39
INTEGER	63	40
PacketEnvelope	70	41
RedirectedFromInformation	78	42
intercept	10	43
Intercept Access Function	64, 65, 66, 67, 68, 69, 70, 71, 72, 73, 178	44 45 46 47 48 49
Intercept Access Point	9, 10, 76	50
Call-Identifying Information	21	51
Circuit	24, 24	52
content surveillance	23, 24	53
Home System	84	54
land line	83	55
		56
		57
		58
		59

1 Packet Data 24, **28**
2 Redirecting System 85
3 Serving System 84
4 Serving System Identification 20
5
6 intercept agent **10**
7 intercept subject **1, 10**
8 Intercept Subject Signaling 23
9 Dialed Digit Extraction 23
10 Subject-initiated Dialing and Signaling 23
11 interceptedGSMSMSPacket **70**
12 interceptedISSMSPacket **70**
13 interceptedUUPacket **70**
14 interface reference points 36, **38**
15 international 77
16 International Mobile Equipment Identity 77
17 International Mobile Station Identity 77
18 Internet Protocol 10
19 Inter-System Link Protocol 10
20 intrasystem handoff *159*
21 IP **10, 92, 93, 95**
22 network address 76
23 ip **78**
24 ipAddress **77**
25 IP-based service 55
26 ISDN **10**
27 -based 55, 77
28 B-channel 92, 93, 94, 95, 96
29 Bearer Capability 96
30 D-channel 92, 93
31 signaling *118*
32 User Part 10
33 isdnBchannel **78**
34 isdnDchannel **78**
35 isdnHighLayer **78**
36 isdnLowLayer **78**
37 isdnUserToUserSignaling
38 PacketEnvelope **70**
39 ISLP **10, 95**
40 ISSIAP 22
41 ISUP **10, 94**
42 Bearer Capability 96
43 generic address 77
44 generic digits 77
45 generic name 77
46 signaling *118*
47 ITU-R **10**
48
49
50
51
52
53
54
55
56
57
58
59

ITU-T 10	1
J	2
JoinedIdentity 46	3
J-STD-025A 1, 21, 26, 162	4
K	5
kbits 10	6
L	7
lack of CDC and CCC synchronization 33	8
LAES 10	9
Protocol 10	10
LAESP 10 , 19, 62, 92, 93	11
encoding objectives 62	12
parameter identifier encoding 63	13
land line intercept access points 83	14
LAPB 10 , 78, 92, 93, 95	15
LAPD 10 , 92, 93, 94	16
lastRedirecting PartyIdentity 78	17
Law Enforcement Administration Function 10, 19, 38 , 38	18
Law Enforcement Agency i, xiii, 1	19
law enforcement agency 10	20
Lawfully Authorized Electronic Surveillance 10	21
Protocol 19	22
LEA 1, 2, 5, 6, 10, 10 , 16, 18, 19, 37, 38, 90	23
LEAF 10	24
LEAs 94	25
leg 11	26
Lightweight Presentation Protocol 11	27
line appearances 77	28
scenario 148	29
Link Access Protocol—Balanced 10	30
Link Access Protocol—D-channel 10	31
Location 76	32
Answer 40, 46, 64	33
Origination 54, 69	34
PacketEnvelope 55, 70	35
Release 57, 71	36
looped access 90	37
loss of content 24	38
low layer compatibility 78	39
LPP 11 , 92, 93	40
M	41
M-mandatory 39	42
mandatory 39	43
meet me conference 26	44
memo	45
ConnectionTest 178	46
	47
	48
	49
	50
	51
	52
	53
	54
	55
	56
	57
	58
	59

1 message descriptions **39**
2 Message Transfer Part **11**
3 metallic signaling *118*
4 MF **11**, *94*
5 MF signaling *118*
6 min **77**
7 Mobile Country Code *77*
8 mobile station **11**
9 Mobile Switching Center **11**
10 MOC
11 *See also* mandatory, optional, and conditional **39**
12 modem *90, 95*
13 more than one LEA *20*
14 MS **11**
15 MSC **11**
16 MSCID *75*
17 MTP **11**, *94*
18 mu-law encoding *80*
19 Multi-Frequency **11**
20 multi-party *26*
21 *awaiting answer connection 126*
22 *connected and awaiting answer connection 126*
23 Multiple CIAPs *24*
24 multiplexed *20*
25 N
26 NAMPS **11**, *29*
27 network
28 *answering call scenario 156*
29 network address **11**
30 network provided calling number *77*
31 network reference model *36*
32 Network Signaling *23*
33 *In-band and Out-of-band Signaling 23*
34 *in-band and out-of-band signaling 9*
35 message *50*
36 *Signal 52*
37 *AlertingSignal 52*
38 *SubjectAudibleSignal 52*
39 *TerminalDisplayInfo 52*
40 networkAddress
41 *ServingSystem 58, 72*
42 new
43 messages *82*
44 parameter fields *82*
45 parameter values *82*
46 parameters *82*
47
48
49
50
51
52
53
54
55
56
57
58
59

no address	77	1
no input	69	2
Non-Call Associated Information Surveillance Service Description—Serving System IAP	20	3
non-call associated services	16	4
NSIAP	22	5
NULL	75	6
number translation	53	7
input	69	8
scenario	149, 150	9
single system scenario	150	10
numRedirections	78	11
O		12
O-optional	39	13
OCTET STRING		14
BearerCapability	75	15
ISDN high layer		16
PartyIdentity	78	17
ISDN low layer		18
PartyIdentity	78	19
Packet Envelope		20
GSM SMS packet	70	21
TIA/EIA-41 SMS packet	70	22
user-to-user packet	70	23
PartyIdentity subaddress	77	24
off-hook	11, 119	25
one-way paging	29	26
on-hook	11, 120	27
operator	77	28
optional	39, 80, 81, 82	29
origin	6, 11, 16	30
originalCalled PartyIdentity	78	31
originalDestinationAddress	70	32
originalOriginatingAddress	70	33
originating calls	88	34
Originating System	12, 152	35
originatingAddress	70	36
Origination	22, 53 , 64, 69 , 127, 128, 129, 130, 140, 141, 142, 143, 144, 145, 148, 149, 150, 156, 157, 163, 166, 170, 176	37
origination	11, 64, 130	38
out-of-band signaling	80	39
P		40
Packet Data	97	41
Packet Data CCC Delivery	114	42
Packet Data IAP	24, 28	43
Packet Data Intercept Access Point	11	44
PacketEnvelope	32, 64, 70	45
		46
		47
		48
		49
		50
		51
		52
		53
		54
		55
		56
		57
		58
		59

1 packetEnvelope **64**
2 packetInformation
3 PacketEnvelope 52, 55, **70**
4 packet-mode **11**, 13, 15, 28, 29, 41, 42, 43, 55, 65, 80, 96
5 CCC 95
6 PACS **11**
7 paging 29
8 parameter **63**
9 encoding objectives 62
10 extension 62
11 identifier encoding 63
12 in existing messages 81
13 partial dial 53
14 scenario 127
15 PartyIdentity **77**
16 Answer 64
17 Answering 40, 46
18 called 54, 60
19 calling 54, 60
20 Origination 54, 66, 69, 78
21 PacketEnvelope 70
22 RedirectedFromInformation 78
23 Redirected-to 56
24 Redirection 56, 71
25 TerminationAttempt 60, 73, 73
26 password 27
27 call acceptance scenario 154, 155
28 screening 40
29 path minimization scenario 159
30 PCM **11**, 80
31 PCS **11**
32 PCS1900 **11**, 29
33 PDIAP **11**, 83
34 PDU **12**
35 PDUType **78**
36 CCOpen 43, 65
37 circuit-mode vs. packet-mode 96
38 pen register **12**
39 permanent **15**
40 personal base station 21
41 personal identification number 27
42 personal mobility **12**, 56, 72
43 PIN 27
44 Pivoted Delivery Function 119
45 Plain Old Telephone Service 119
46 Point-to-Point Protocol 12
47
48
49
50
51
52
53
54
55
56
57
58
59

port 77	1
port identity	2
PartyIdentity 77	3
POTS 12, 119	4
PPP 12, 92	5
ppp 78	6
pre-answer abandon scenario <i>128</i>	7
previous calls	8
Change 44, 47, 48, 49, 52, 59, 65	9
PRI 12	10
Primary Rate Interface 12	11
primitive 63	12
PRIVATE 63, 63	13
private network 53	14
private number 77	15
Procedures 62	16
Protocol Data Unit 12	17
protocol extension 63	18
PSTN 12, 95	19
Public Switched Telephone Network 12	20
pulse code modulation 12, 80	21
Q	22
Q.931 78, 94	23
Q.932 78, 92, 93	24
R	25
reasonably available 17	26
recall 12	27
answer 40	28
scenario <i>132, 156</i>	29
trigger 60	30
receive 19	31
receive path 19, 76	32
receiverAddress PartyIdentity 70	33
redirected 60	34
RedirectedFromInformation 78	35
scenario <i>158</i>	36
TerminationAttempt 60, 73	37
redirectedTo PartyIdentity	38
Redirection 56, 71	39
Redirecting System 12, 29, 85, 152, 157, 158	40
intercept access points 85	41
Redirection 22, 56, 64, 71, 146, 147, 151, 152, 154, 155, 158	42
redirection 64	43
action 28	44
alerting <i>125</i>	45
await answer symbol <i>125</i>	46

1 connected symbol *125*
2 to party *76*
3
4 reference point a **38**
5 reference point b **38**
6 reference point c **39**
7 reference point d **39**, *88*
8 reference point e **39**, *88*, *89*, *90*
9
10 registration **12**
11 Release *22*, **57**, *64*, *71*, *127*, *128*, *129*, *130*, *131*, *133*, *134*, *135*, *137*, *138*, *139*, *140*, *142*, *144*,
12 *145*, *146*, *147*, *149*, *150*, *151*, *153*, *154*, *155*, *156*, *157*, *158*, *160*, *175*
13 ISUP *109*, *110*
14
15 release **64**
16 (action) *5*, *8*, *11*, **13**, *15*, *41*, *57*, *71*, *98*, *102*, *104*, *105*, *107*, *109*, *110*, *111*, *113*, *114*, *116*,
17 *118*, *119*
18 to pivot scenario *157*
19 re-origination scenario *130*
20 restricted *77*
21 resulting calls
22 Change *44*, *49*, **65**
23
24 roaming **13**, *14*
25 routing *53*
26
27 S
28
29 screening service *77*
30 seizure *119*
31 senderAddress PartyIdentity **70**
32 sending PartyIdentity
33 PacketEnvelope **70**
34
35 separate logical channels *20*
36 separated **19**, *19*, *76*, *89*, *97*, **117**
37 sepCCCpair **76**
38 sepRecvCCC **76**
39 sepXmitCCC **76**
40
41 SEQUENCE *64*, *65*, *66*, *68*, *69*, *70*, *71*, *72*, *73*, *75*, *76*, *77*, *78*, *82*, *178*
42 SEQUENCE OF *65*, *77*
43
44 sequenceNumber **75**
45 Serial Link Internet Protocol *13*
46 service area *1*, *13*, *58*
47 ServingSystem *72*
48 Service Profile Identifier *77*
49 Service Provider Administration Function *13*, *18*, **38**, *38*, *39*
50 Serving System *9*, **13**, *21*, *29*, *84*, *87*, *152*, *157*
51 intercept access points *84*
52 Serving System Identification Intercept Access Point *13*, *20*
53 ServingSystem *58*, *64*, **72**
54 servingSystem **64**
55
56 short message service **13**, *19*, *29*, *55*, *70*
57
58
59

PacketEnvelope	70	1
Signal		2
Subject Audible Signal	52	3
simple incoming call scenario	131	4
simple outgoing call scenario	129	5
SLIP	13, 92	6
SMS	<i>See also</i> short message service	7
smsTeleserviceIdentifier	70	8
SPAF	13	9
special considerations	77	10
speech bearer service	75, 80, 89, 116	11
speed calling		12
scenario	149	13
speed number expansion	53	14
scenario	149	15
speed number translation		16
	150	17
spid	77	18
SSIAP	13, 20, 21, 83	19
static directory number	88, 97	20
CCC Delivery	111	21
station appearances	77	22
subaddress	77	23
subject	1, 13	24
subject's agent	77	25
subject-initiated dialing and signaling information	13	26
SubjectSignal message	59	27
Signal	59	28
DialedDigits	59	29
FeatureKey	59	30
SwitchhookFlash	59	31
surveillance	8, 13	32
SVC	13	33
switched	15	34
switchhook flash	120	35
synchronization of CDC and CCC	33	36
syntax definitions	63	37
System Identity		38
Redirection	56	39
System Serving	152	40
systemIdentity		41
CallIdentity	75	42
Redirection	71	43
Release	57, 71	44
ServingSystem	58, 72	45
		46
		47
		48
		49
		50
		51
		52
		53
		54
		55
		56
		57
		58
		59

T

T1.607

High Layer Compatibility 78

Low Layer Compatibility 78

Subaddress 77

tag **63**TCP **13**, 92, 93, 95

TCP/IP services 29

TDMA **13**, 29tei **77**

telecommunication carrier 14

telecommunication service provider i, xiii, 1, **14**, 14telecommunication support services **14**

Temporary Local Directory Number 152

termAttempt **64**

Terminal Equipment Identity 77

terminal mobility **14**, 56, 58, 72termination **6**, **14**, **16**TerminationAttempt 22, **60**, 64, **73**, 131, 133, 134, 135, 137, 138, 139, 142, 143, 145, 146, 147, 148, 151, 152, 154, 155, 156, 158, 164, 167, 171, 174, 175

three-way calling 26

scenario 141

TIA/EIA-41 12, 29, 55, 70, 152

tiaEia41ShortMessageService

PacketEnvelope **70**TimeStamp **79**

Answer 40, 46, 64

CCClose 41, 65

CCOpen 43, 65

Change 44, 47, 48, 49, 52, 59, 65

ConnectionTest 178

Origination 54, 66, 67, 68, 69

PacketEnvelope 55, 70

Redirection 56, 71

Release 57, 71

ServingSystem 58, 72

TerminationAttempt 60, 73

timing information **14**, 16

transfer recall 12, 40, 60

transfer semantics 62

transfer syntax 62

TransitCarrierIdentity **79**

Origination 54, 69

Redirection 56, 71

translation 53

input 69

scenario	149	1
single system scenario	150	2
translationInput		3
Origination	69, 150	4
transmission	14	5
Transmission Control Protocol	13	6
transmission devices	90	7
transmit path	19, 76	8
transparent	14	9
trap and trace device	14	10
trunk group	77, 88, 97	11
CCC delivery	103	12
trunk identity	76	13
trunk number	77	14
trunkId	77	15
PartyIdentity		16
Answer	154, 155	17
TerminationAttempt	156	18
TSP	6, 10, 14, 14, 15, 16, 72, 75, 119	19
two-way		20
communication	25	21
paging	29	22
type	63	23
U		24
unique identity		25
CCC	20	26
UNIVERSAL	63, 63	27
unobtrusively	15, 21, 24	28
URL	15	29
USC	15	30
user interaction	27	31
user provided calling number	77	32
userInput		33
Origination	66, 69, 127, 128, 129, 130, 140, 141, 142, 143, 144, 145, 148, 149, 150, 156, 157, 163, 166, 170, 176	34
userProvided	77	35
user-to-user signaling	15, 55	36
UTC	15	37
V		38
V.32	92	39
value	63	40
virtual circuit	15	41
VisibleString	77	42
appearance identity		43
PartyIdentity	77	44
calling card number		45

1 PartyIdentity 77
2 CaseIdentity 75
3 CCCIIdentity 76
4 combined CCC
5 CCCIIdentity 76
6 context
7 PartyIdentity 77
8 directory number
9 PartyIdentity 77
10 ESN
11 PartyIdentity 77
12 generic address
13 PartyIdentity 77
14 generic digits
15 PartyIdentity 77
16 generic name
17 PartyIdentity 77
18 IAPSystemIdentity 76
19 IMEI
20 PartyIdentity 77
21 IMSI
22 PartyIdentity 77
23 individual CCC
24 CCCIIdentity 76
25 individual receive path
26 CCCIIdentity 76
27 individual transmit path
28 CCCIIdentity 76
29 IP address
30 PartyIdentity 77
31 Location 76
32 memo
33 ConnectionTest 178
34 MIN
35 PartyIdentity 77
36 NetworkAddress
37 ServingSystem 72
38 separated receive path
39 CCCIIdentity 76
40 separated transmit path
41 CCCIIdentity 76
42 sequenceNumber
43 CallIdentity 75
44 SPID
45 PartyIdentity 77
46 SystemIdentity

CallIdentity 75	1
Redirection 71	2
Release 71	3
ServingSystem 72	4
TEI	5
PartyIdentity 77	6
TransitCarrierIdentity 79	7
translationInput	8
Origination 69	9
trunk identity	10
PartyIdentity 77	11
user provided number	12
PartyIdentity 77	13
userInput	14
Origination 69	15
X.121 address	16
PartyIdentity 77	17
voice bearer service 116	18
voice mail 6, 40	19
W	20
WCDMA 15	21
wire communications 15	22
wireless 15	23
wireless IP-based service 55	24
wireline 15	25
X	26
X.208 3, 63	27
X.209 3, 63	28
X.25 78, 92, 93, 95	29
network address 76	30
services 29	31
x121 77	32
x25 78	33
	34
	35
	36
	37
	38
	39
	40
	41
	42
	43
	44
	45
	46
	47
	48
	49
	50
	51
	52
	53
	54
	55
	56
	57
	58
	59